

Р. С. Ф. С. Р.

Пролетарии всех стран, соединяйтесь!

П 532
м-17
УПРАВЛЕНИЕ ПО ПОДГОТОВКЕ АГЕНТОВ ЖИЛИЩНО-ДОРОЖНОГО И ВОДНОГО ТРАНСПОРТА (Учтран)

АТЛАС ЧЕРТЕЖЕЙ
К I-ой ЧАСТИ
КУРСА ГИДРАВЛИКИ

4с

Ф. Е. МАКСИМЕНКО,

ПРОФЕССОРА Московского Института инженеров путей сообщения

ГОСУДАРСТВЕННОЕ ИЗДАТЕЛЬСТВО

1921

2304

1677

Гидротехнический
Институт в Казани

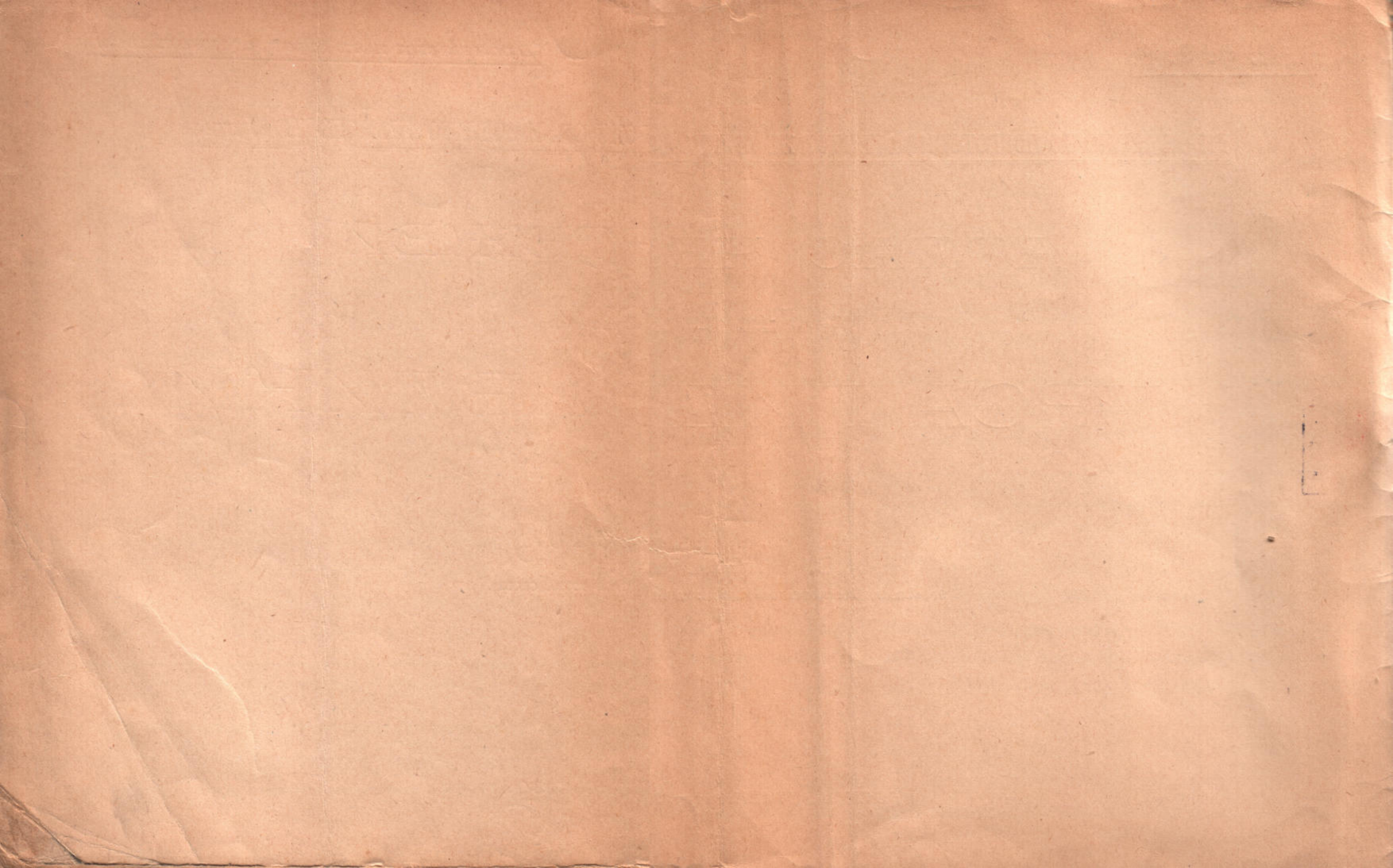

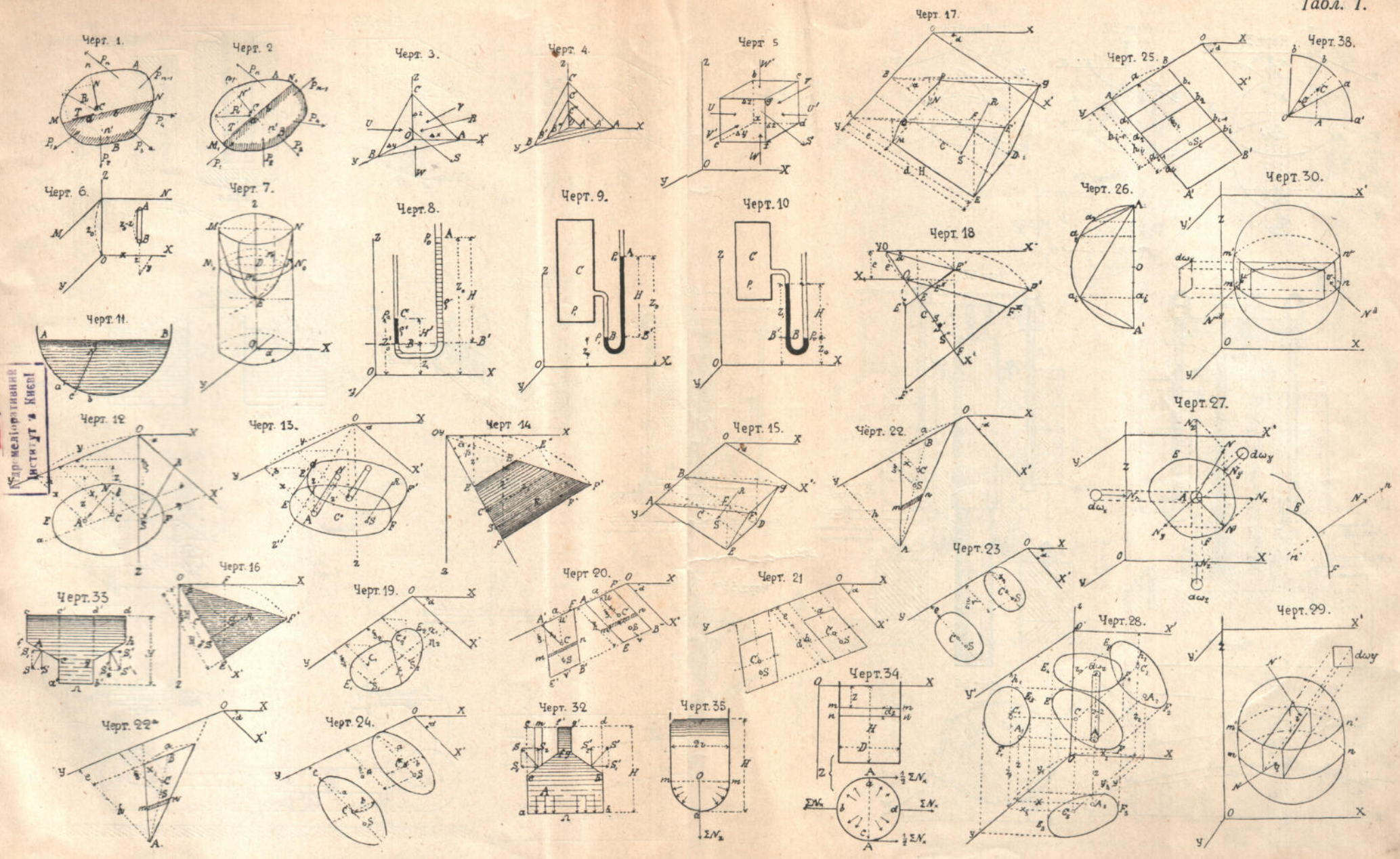

Чер. механический институт в Киев

Табл. 2.

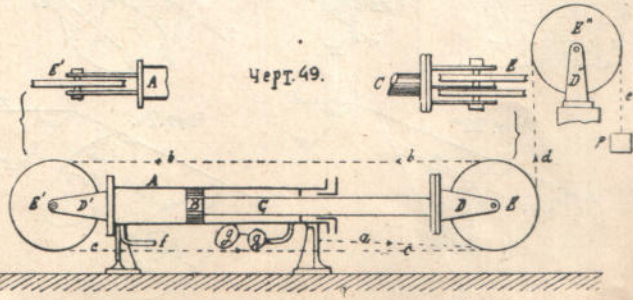
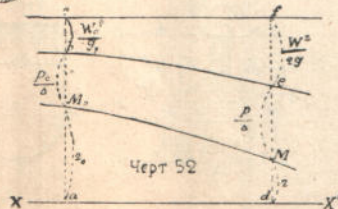
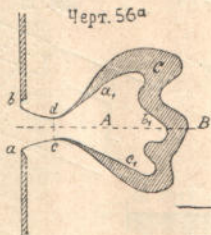
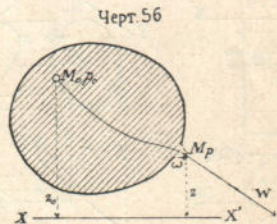
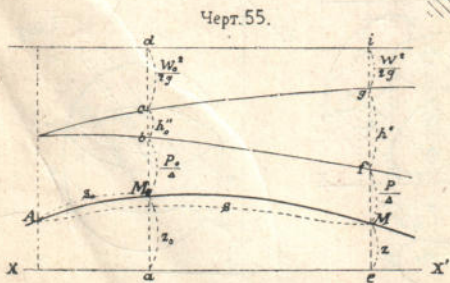
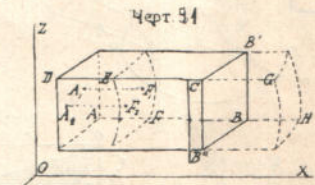
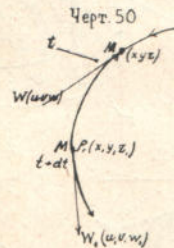
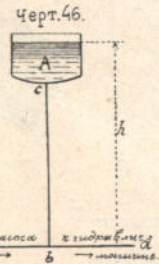
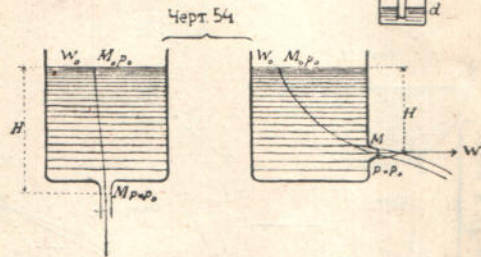
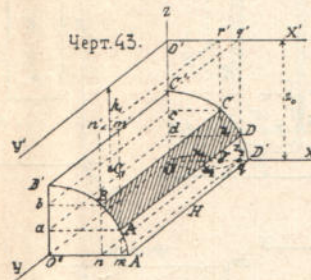
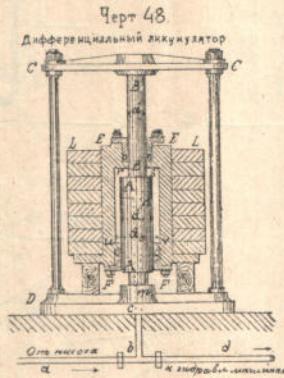
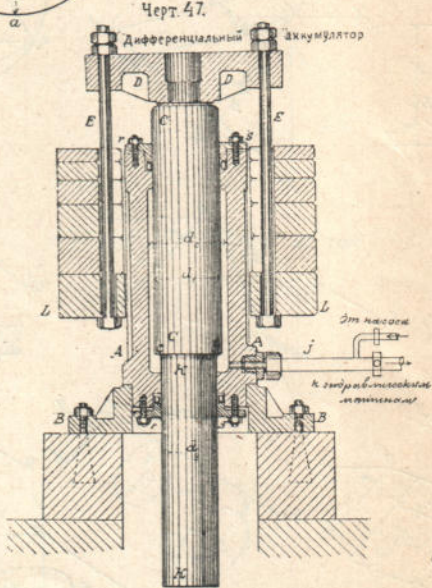
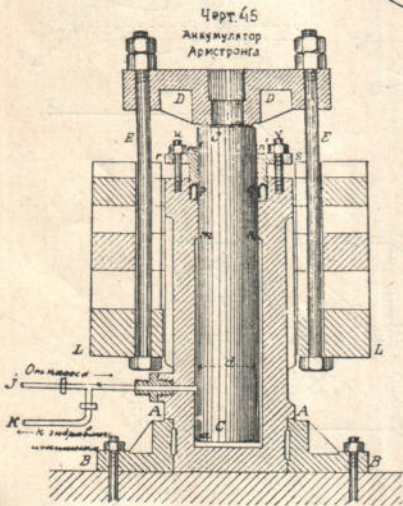
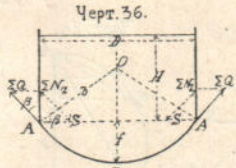
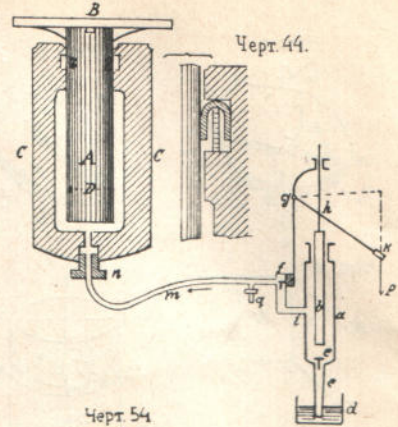
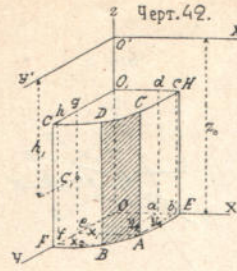
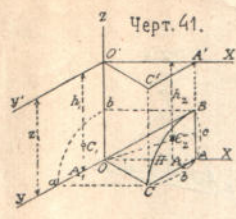
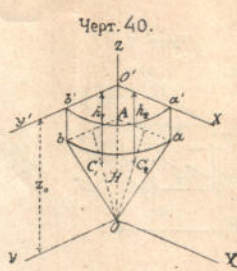
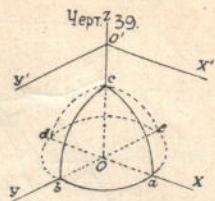
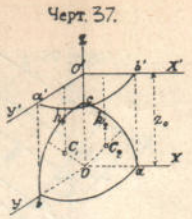
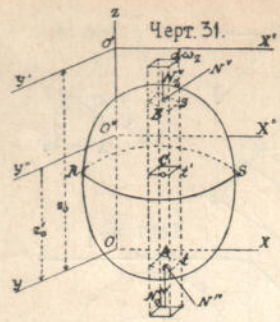

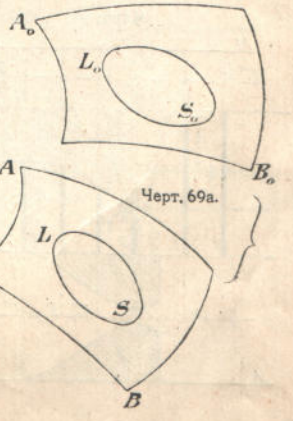
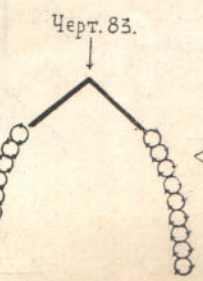
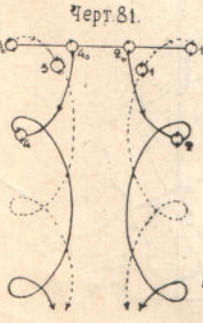
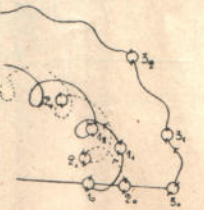
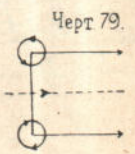
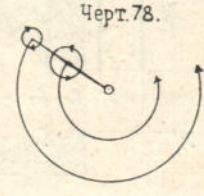
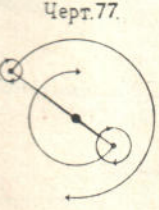
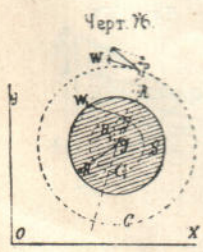
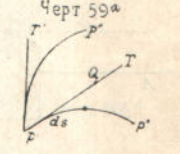
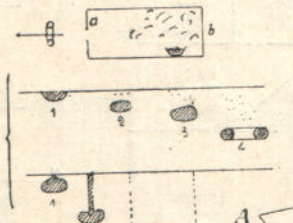
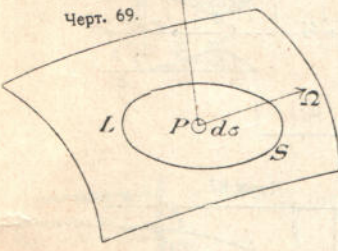
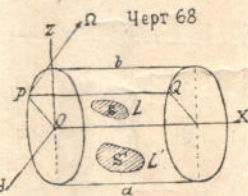
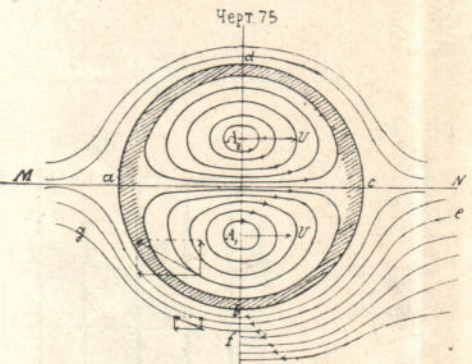
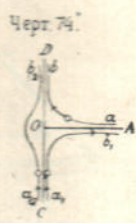
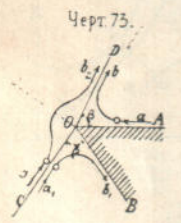
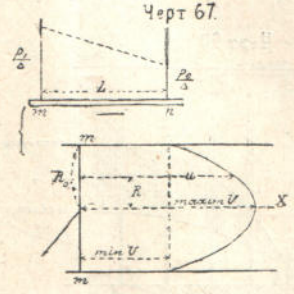
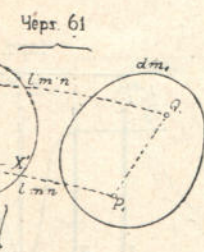
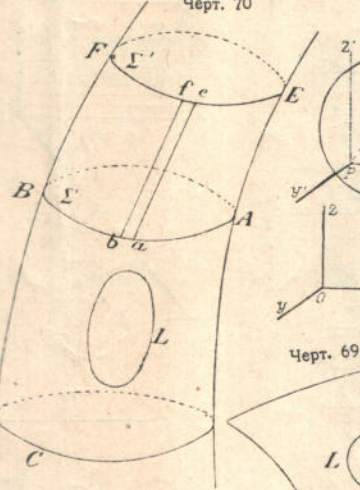
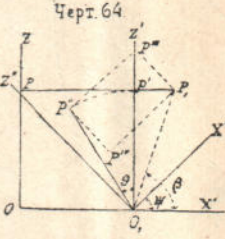
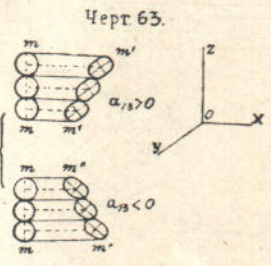
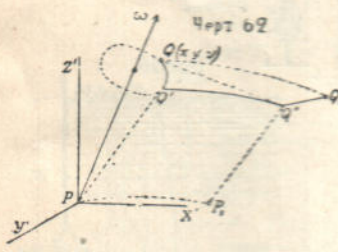
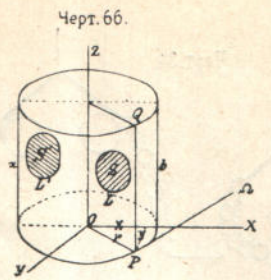
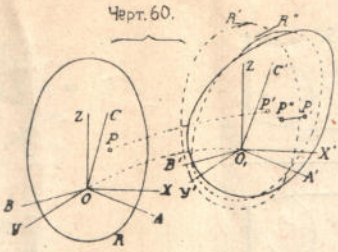
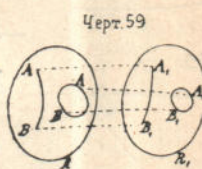
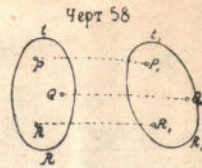
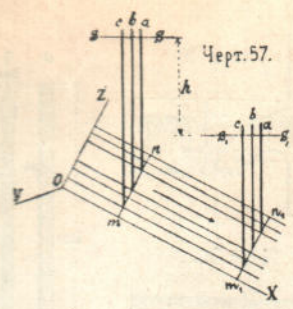
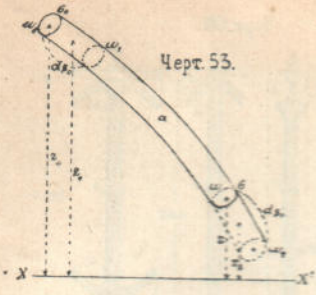

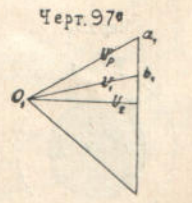
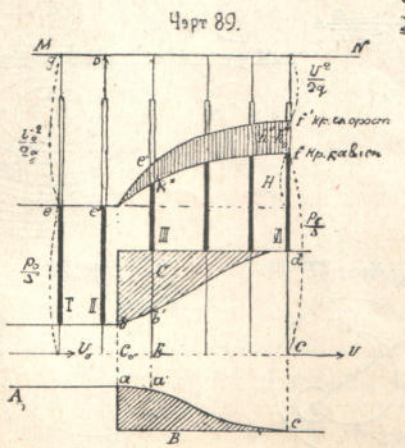
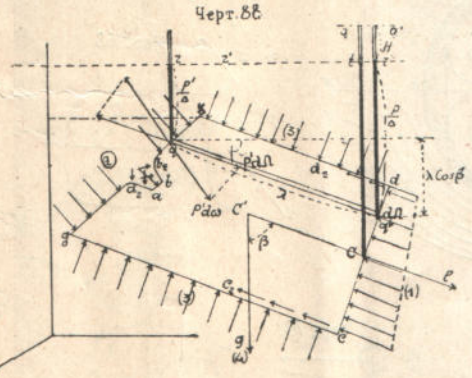
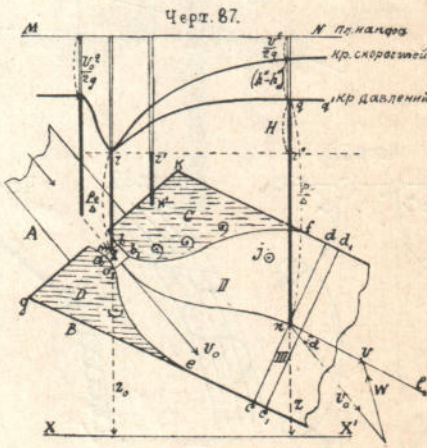
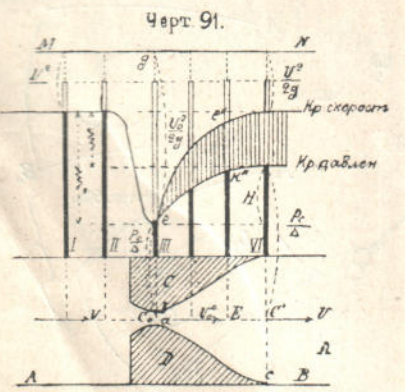
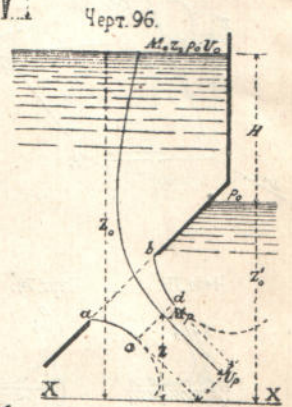
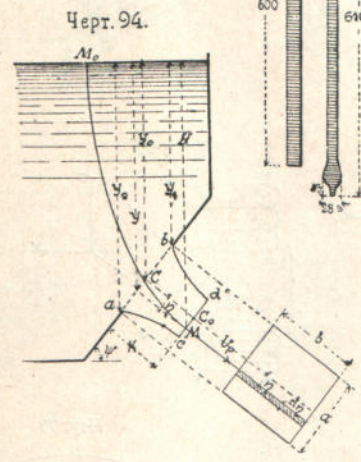
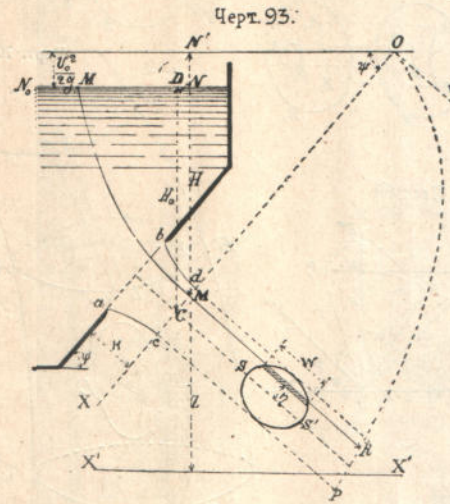
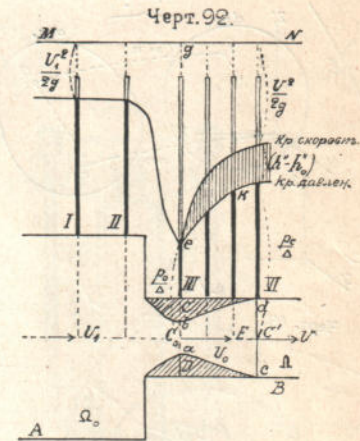
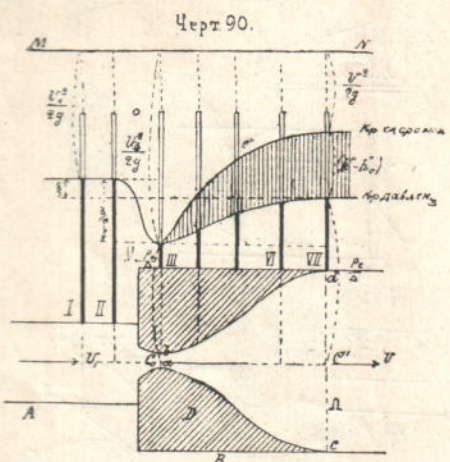
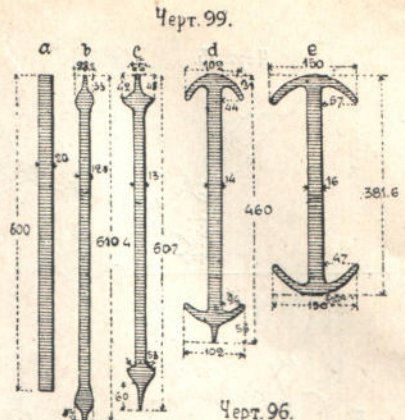
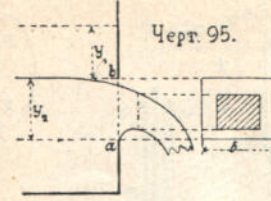
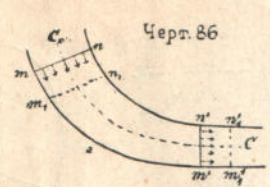
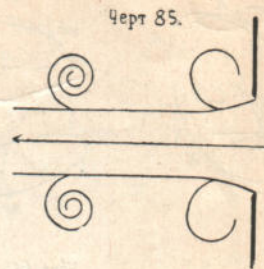
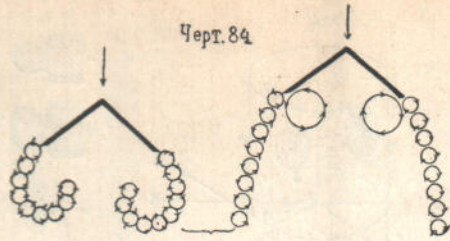

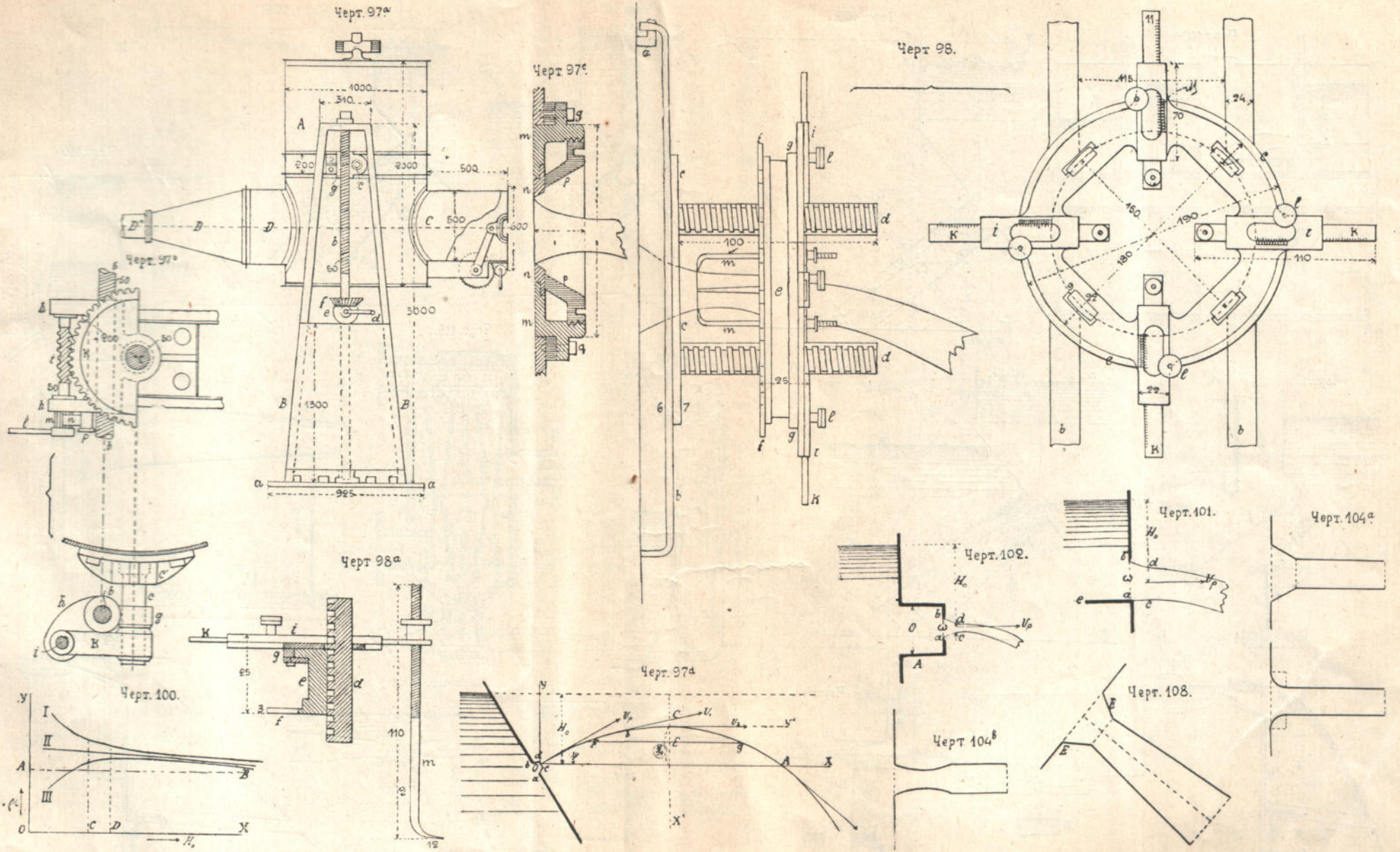

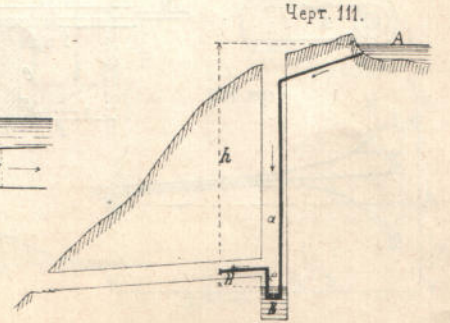
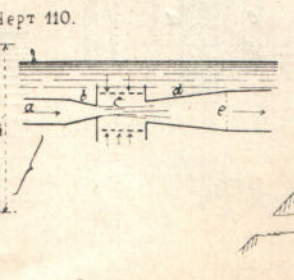
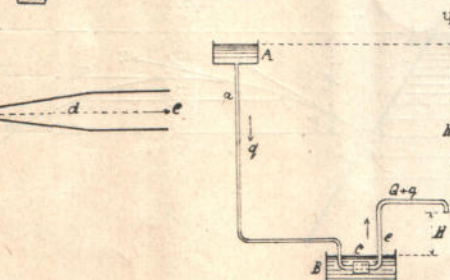
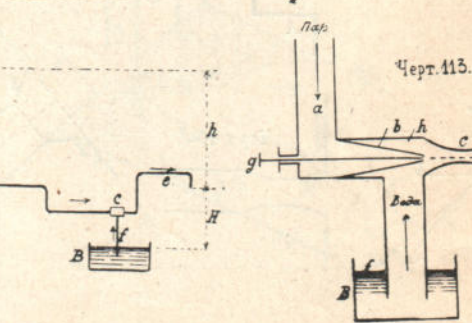
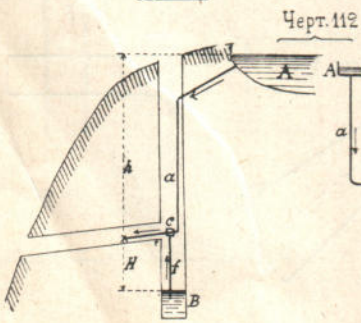
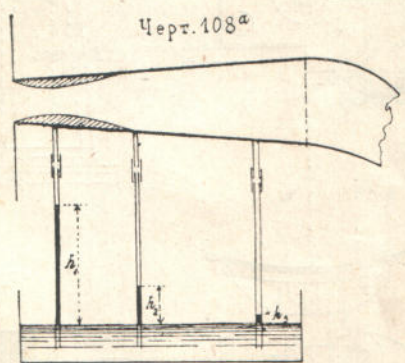
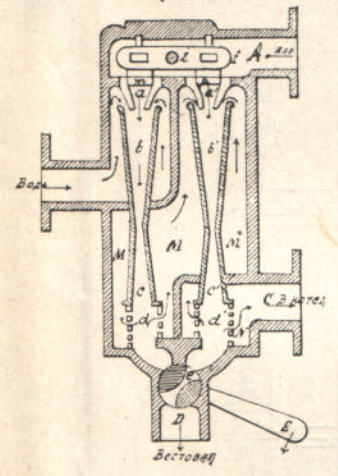
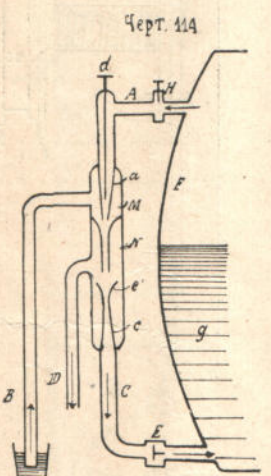
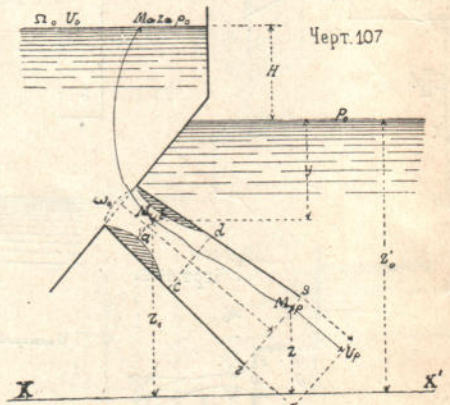
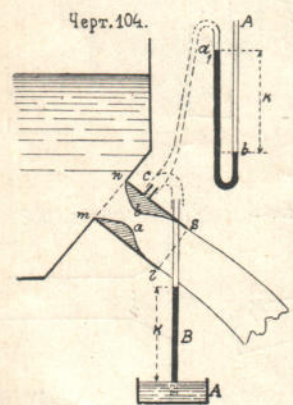
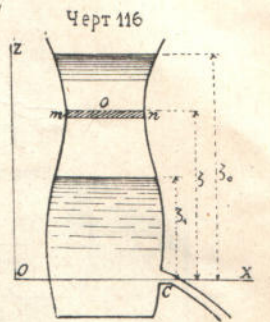
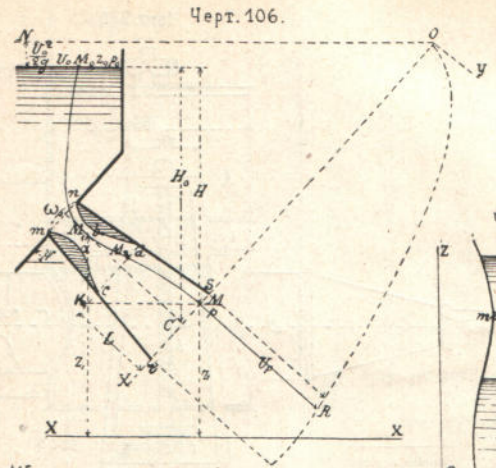
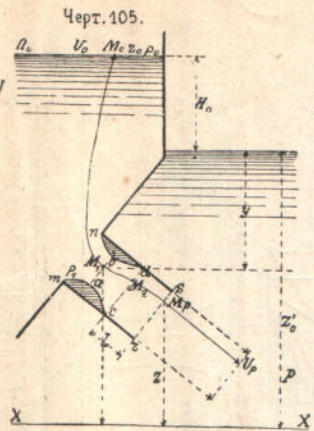
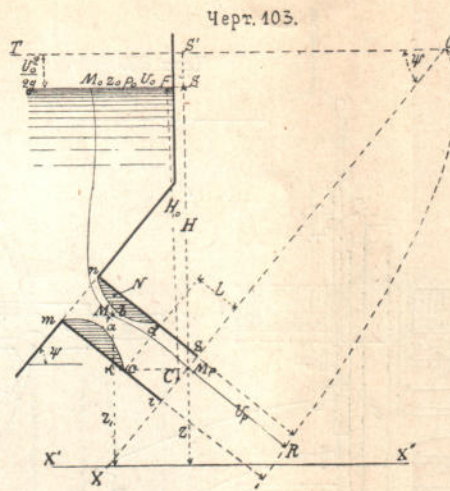
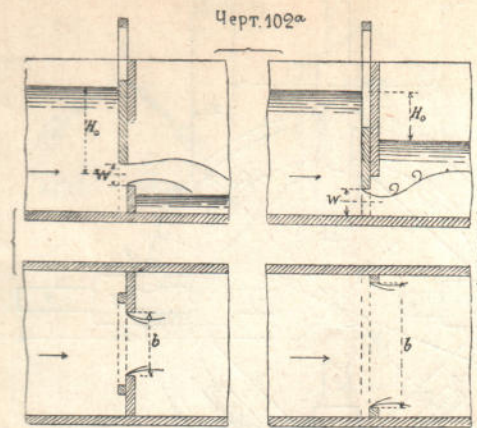

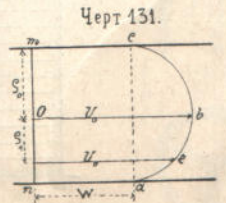
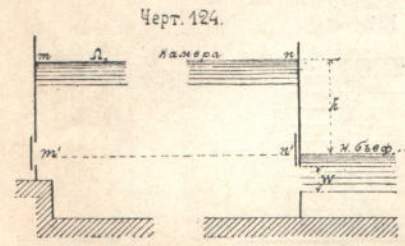
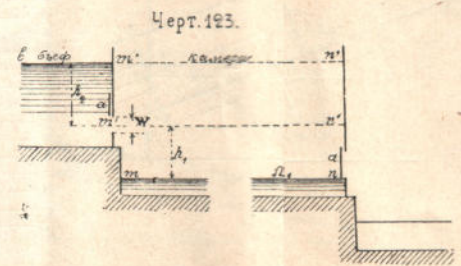
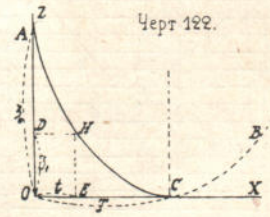
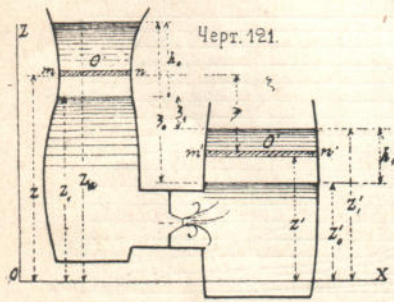
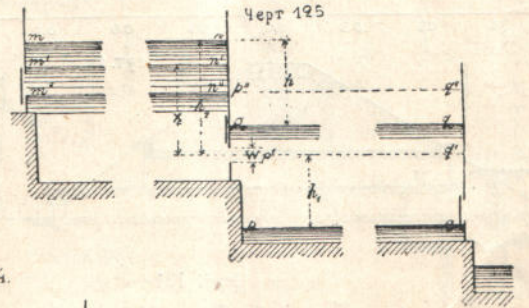
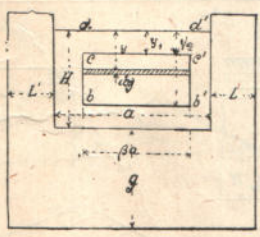
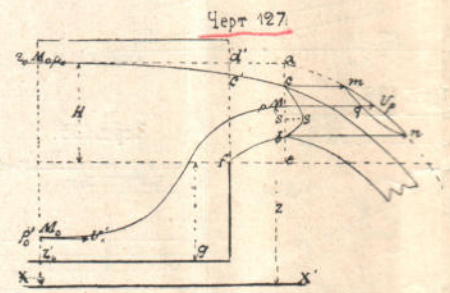
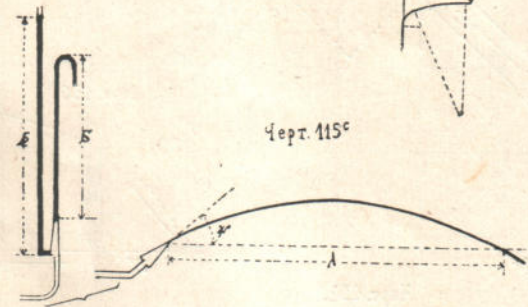
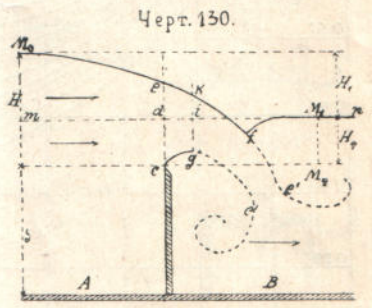
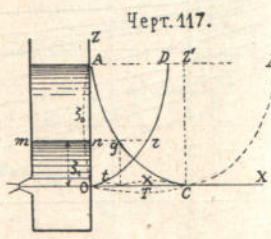
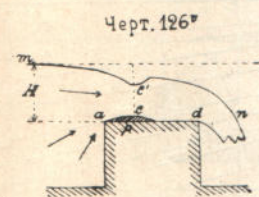
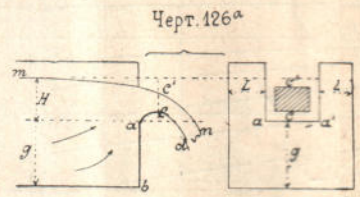
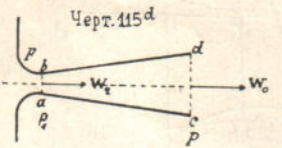
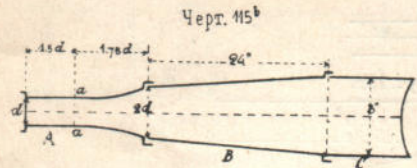
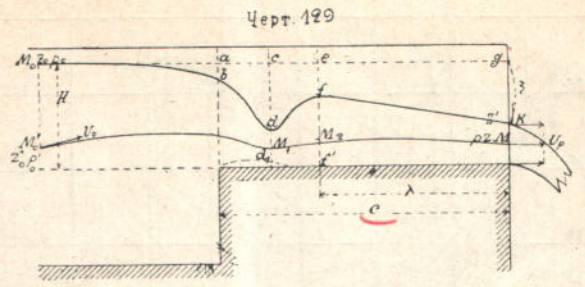
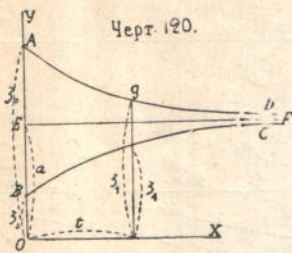
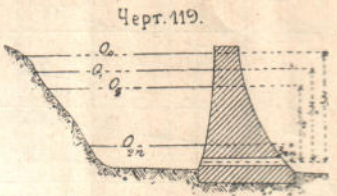
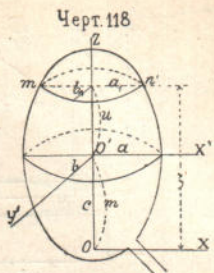
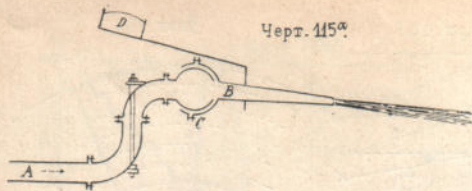

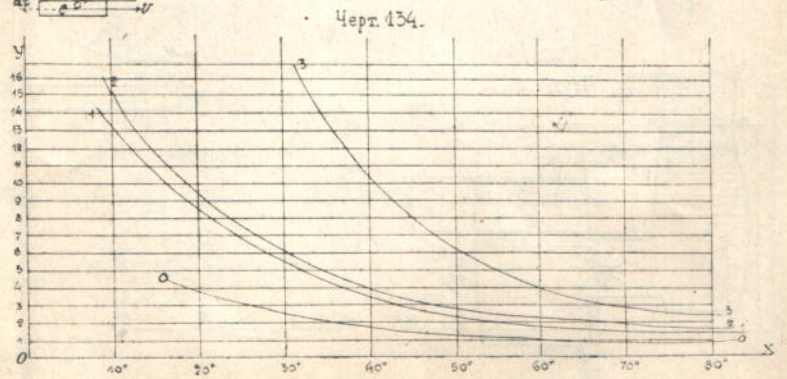
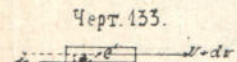
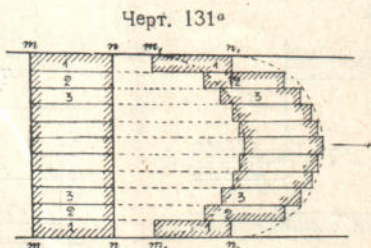
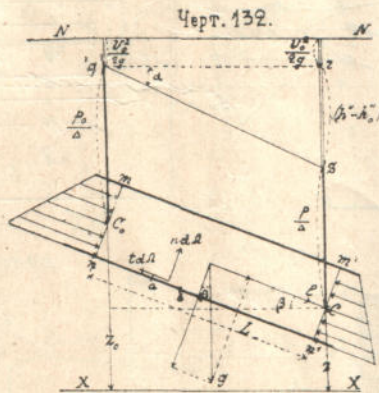
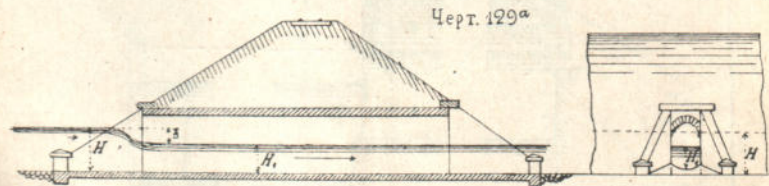
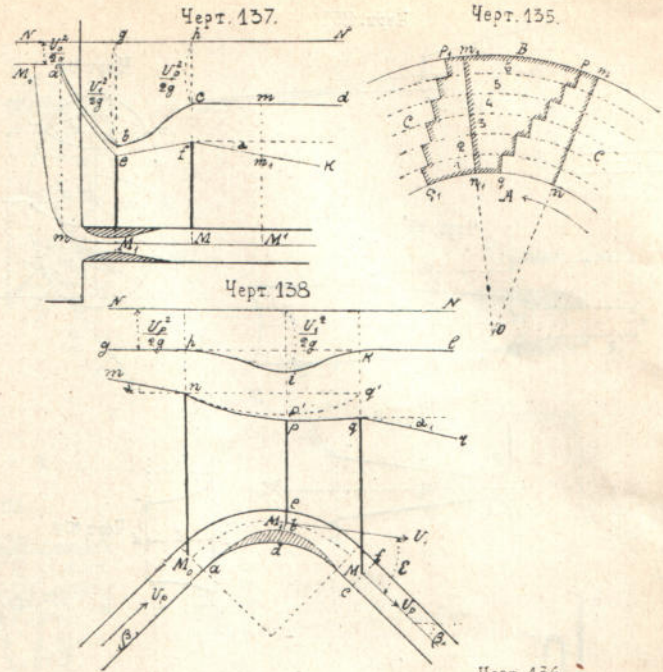
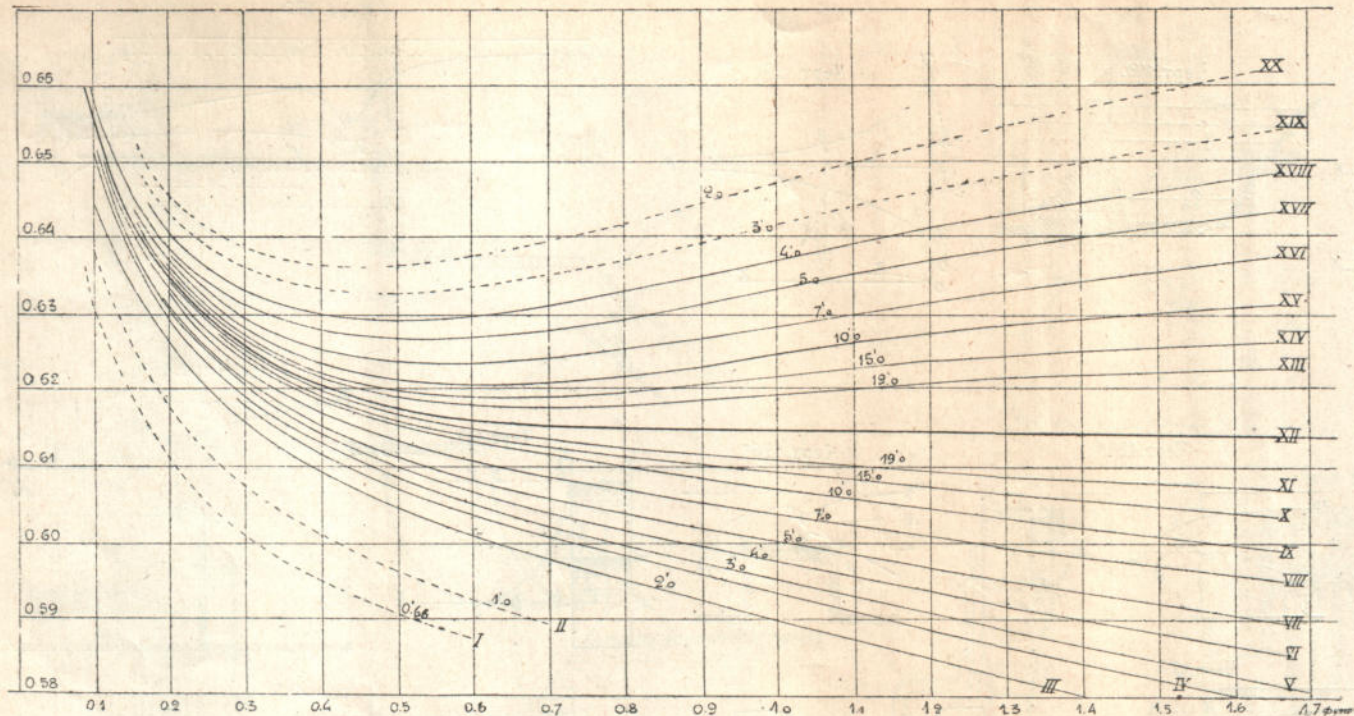

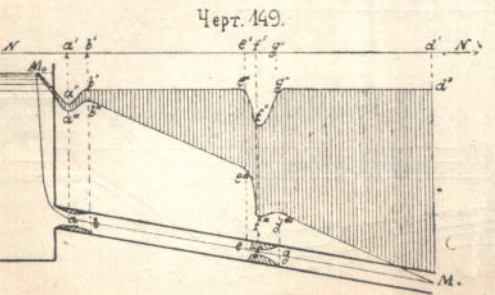
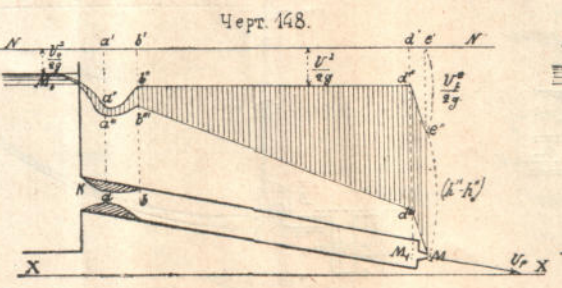
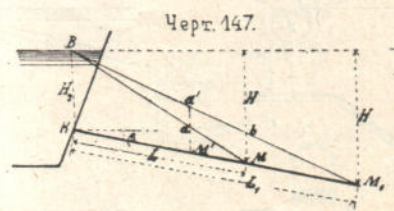
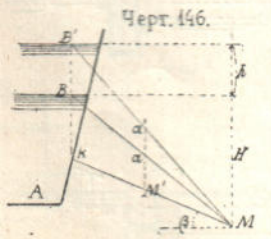
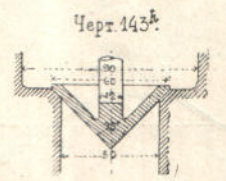
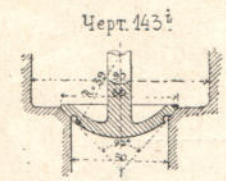
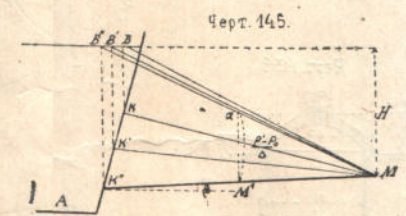
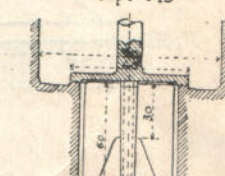
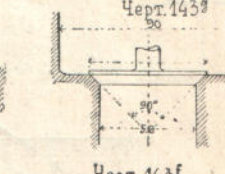
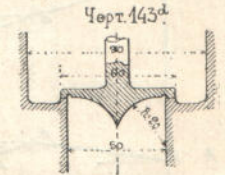
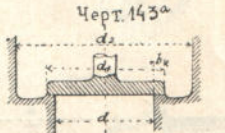
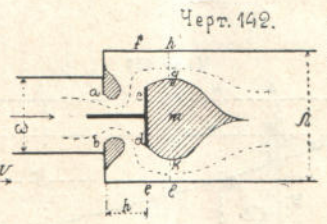
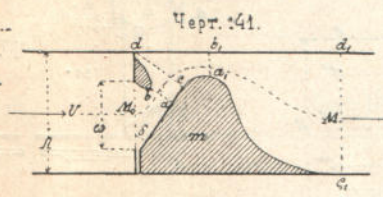
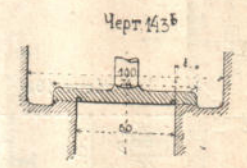
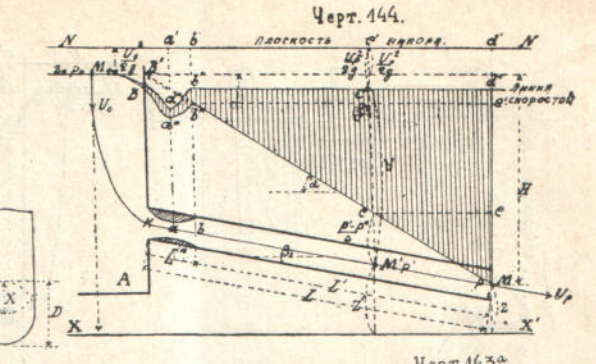
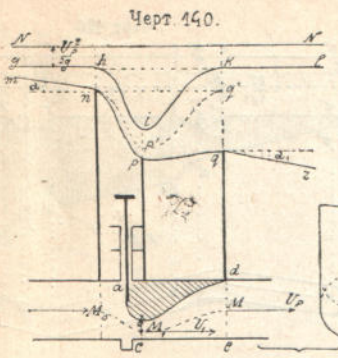
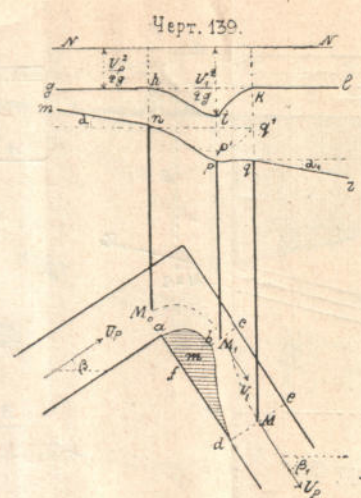
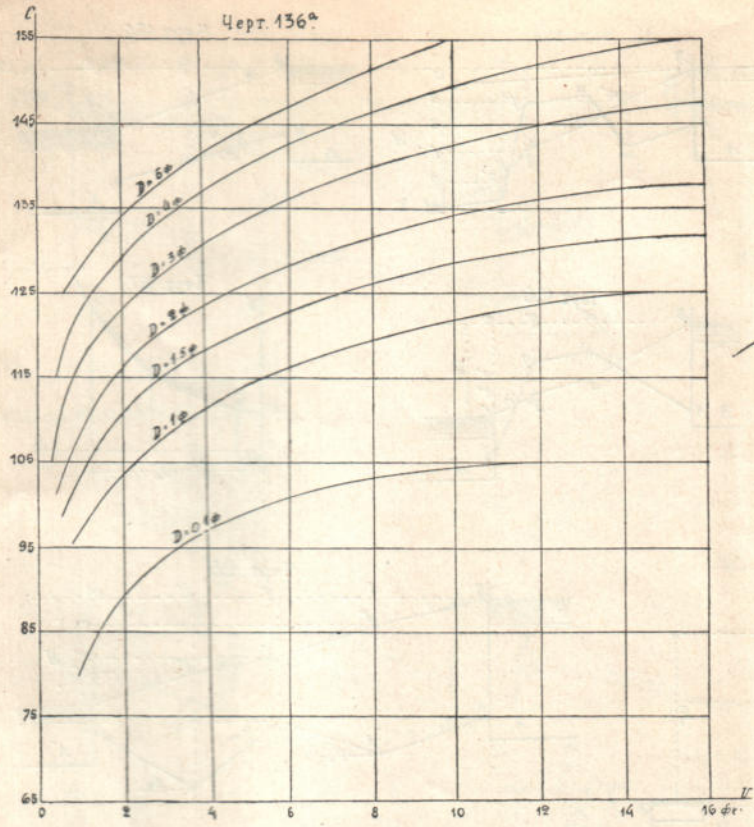

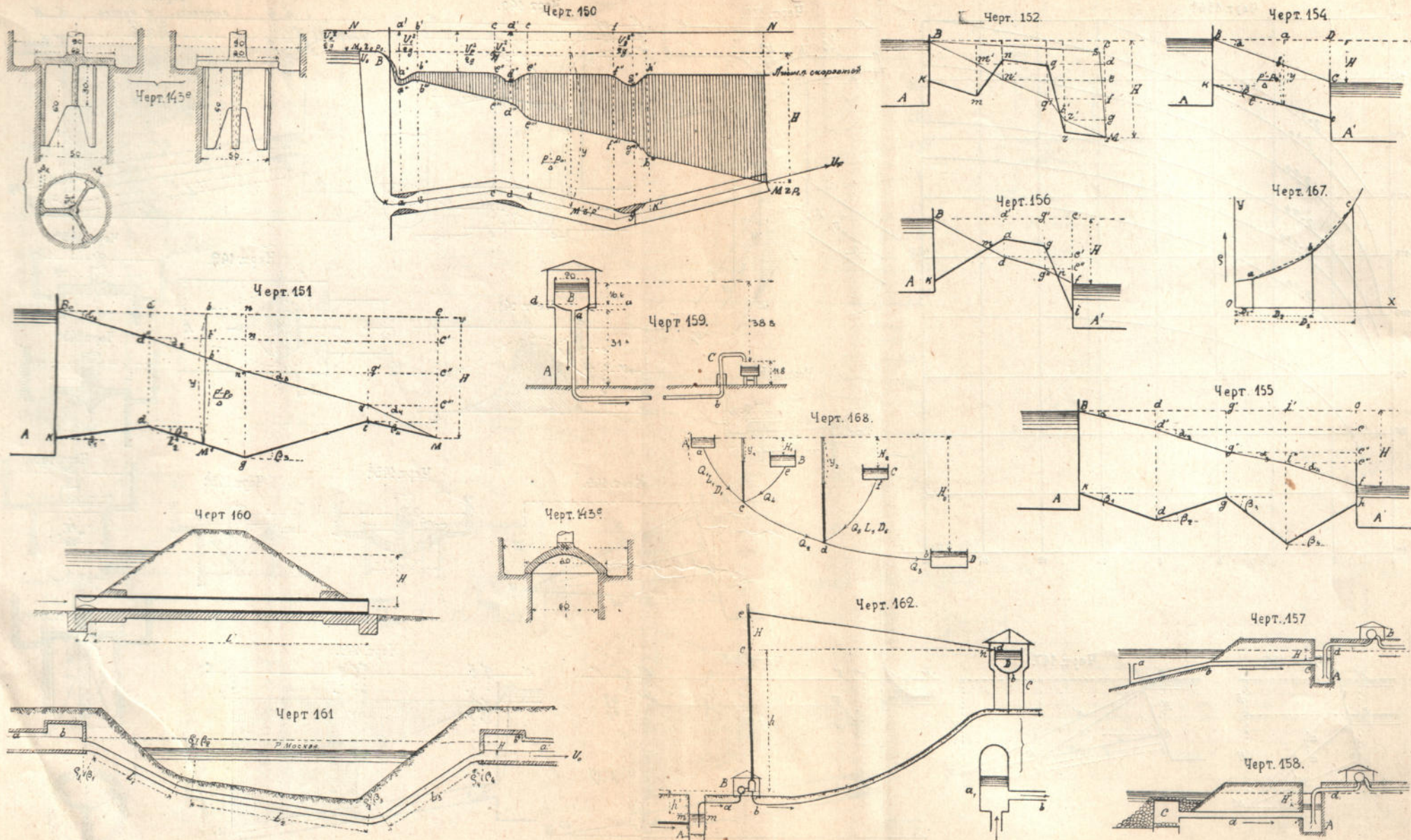

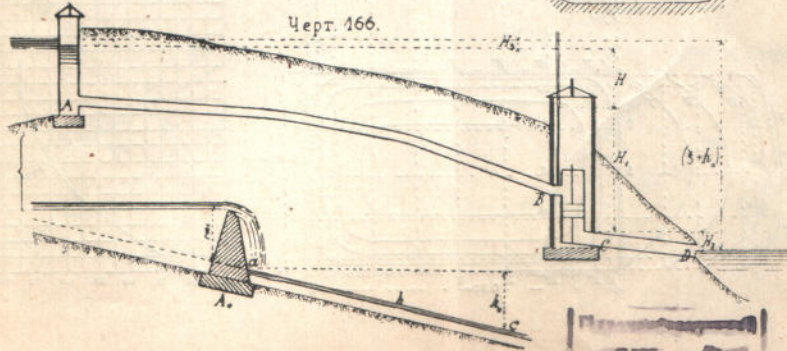
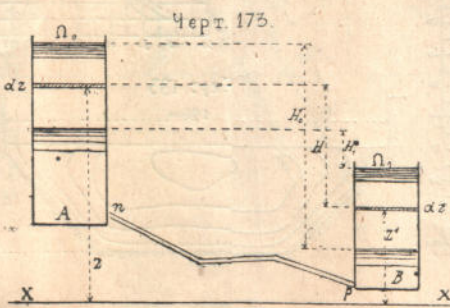
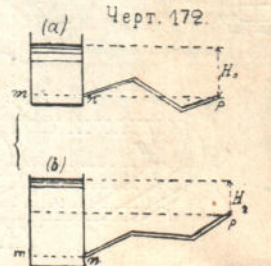
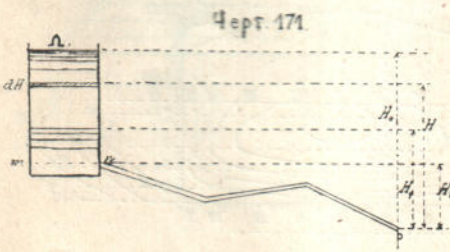
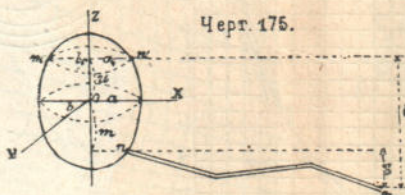
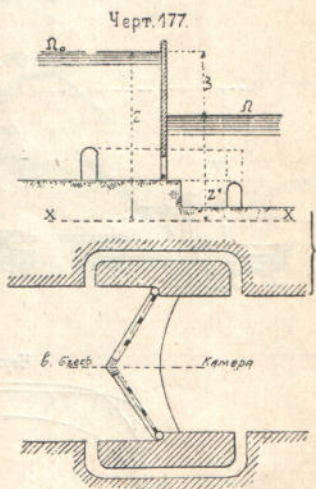
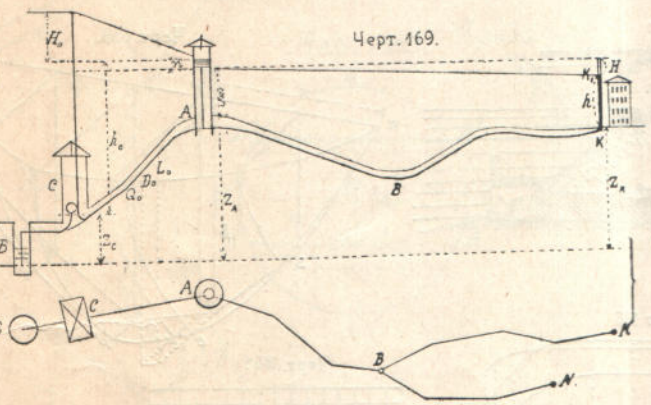
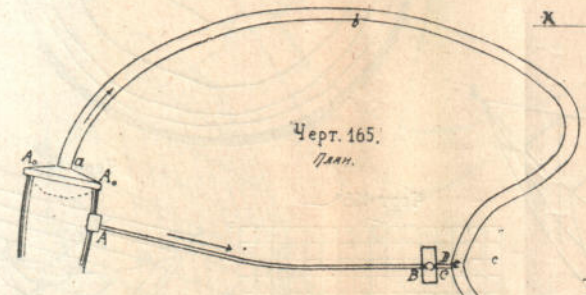
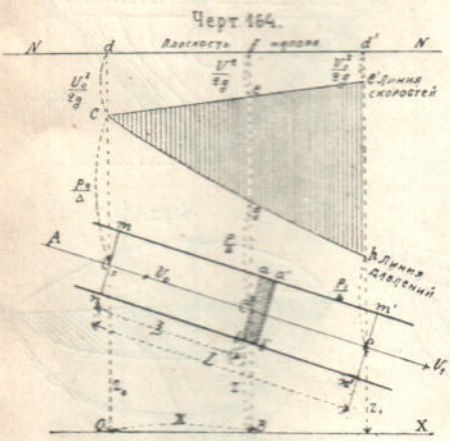
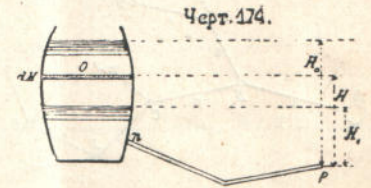
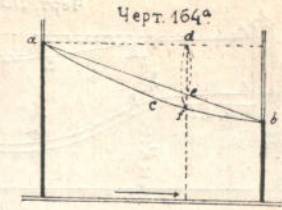
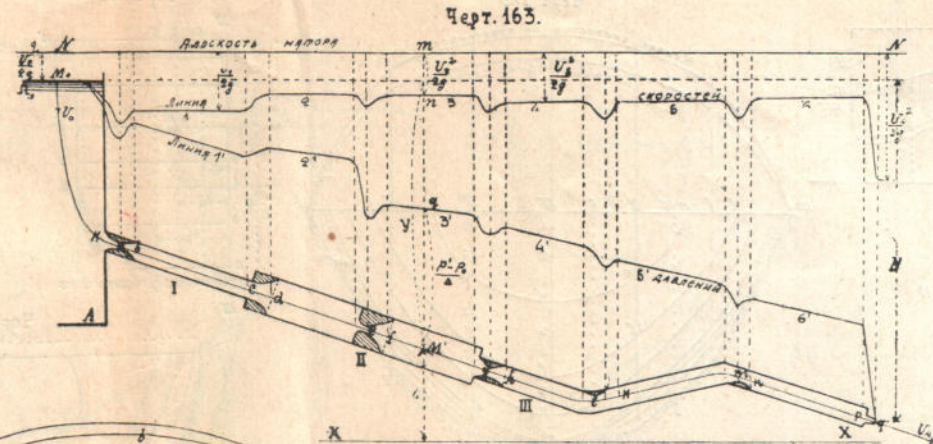
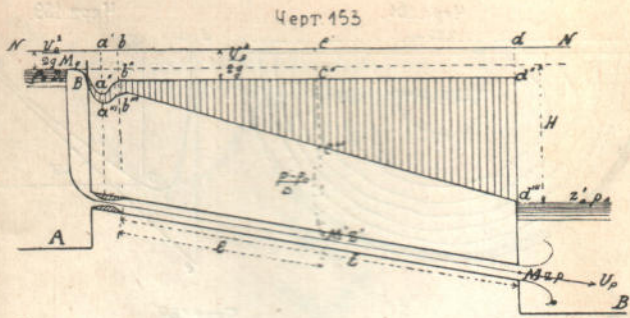

2304

Черт. 170

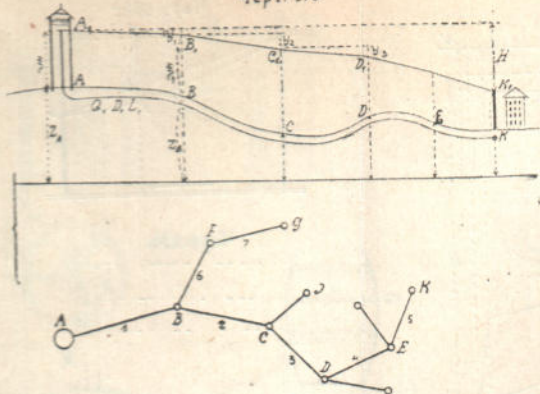

Черт 178

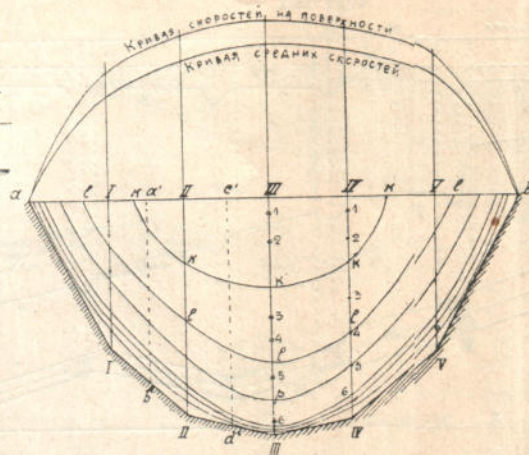

Черт 179

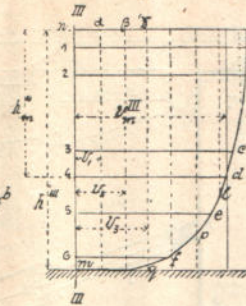

Черт. 181.

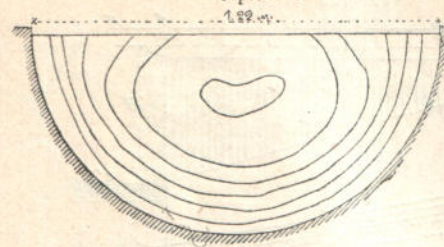

Черт 189

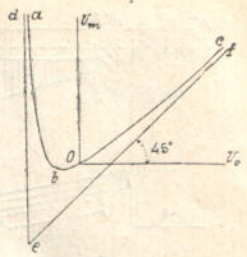

Черт 180.

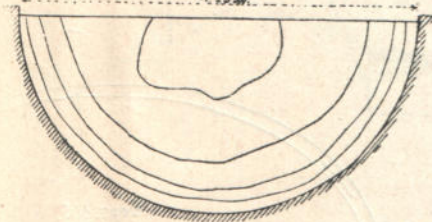

Черт 182.

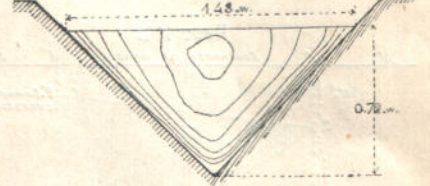

Черт. 176.

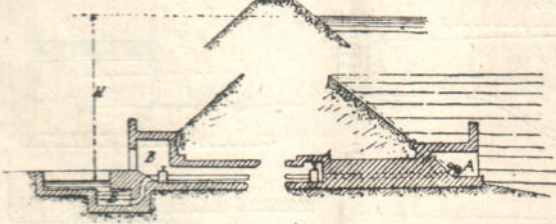

Черт. 186.

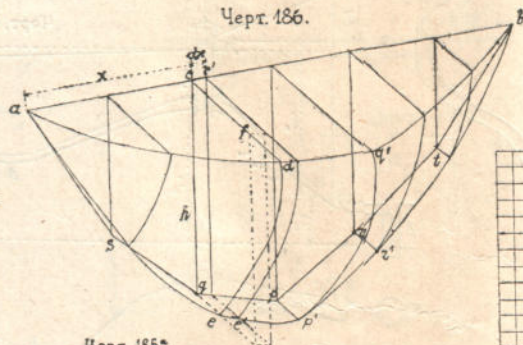

Черт 185^b

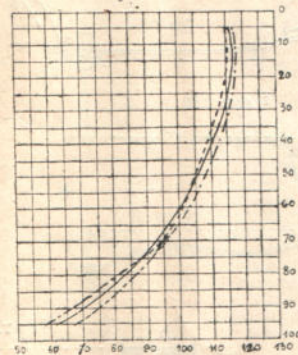

Черт 187.

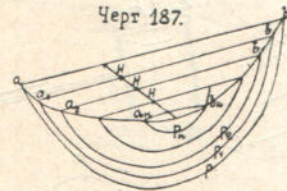

Черт. 188.

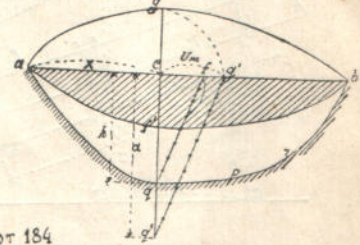

Черт 185

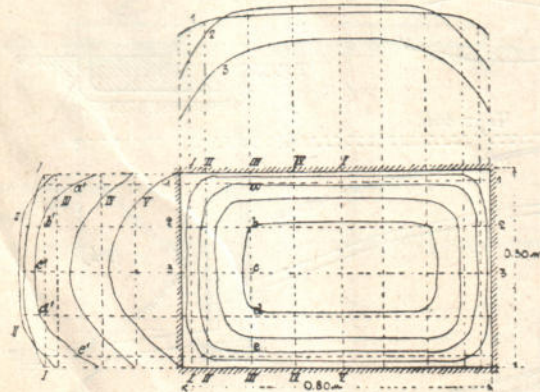

Черт. 185^a

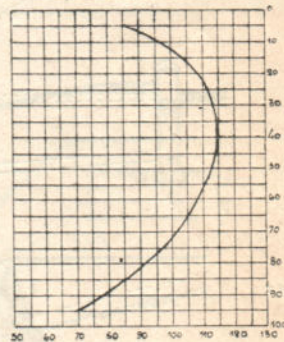

Черт 183

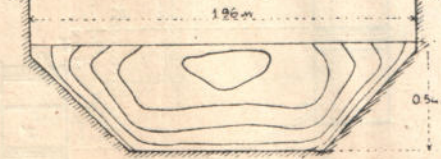

Черт 184

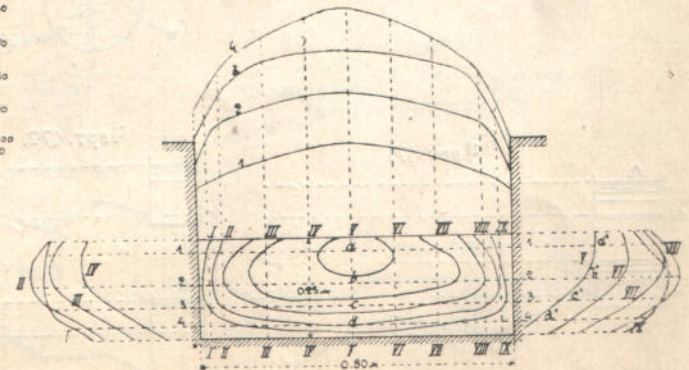

Черт. 191.

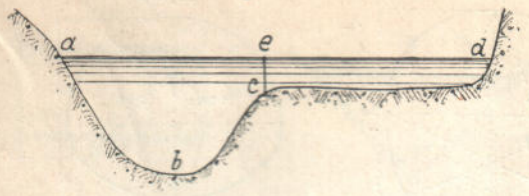

Черт. 192.

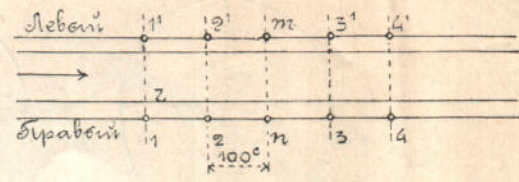

Черт. 196.

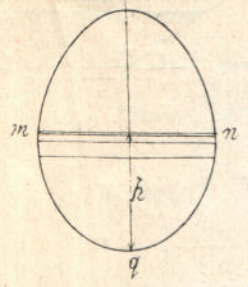

Черт. 194.

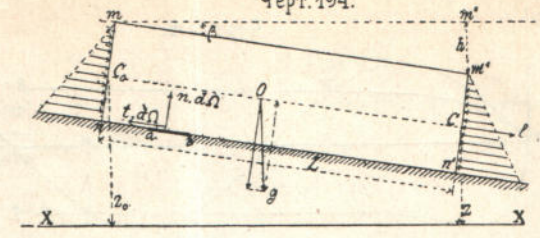

Черт. 198.

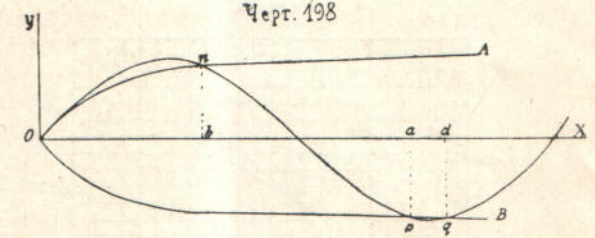

Черт. 193.

Левый.

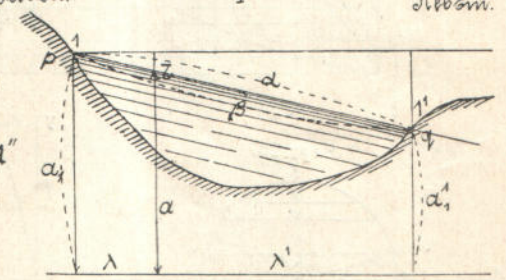

Черт. 197.

Правый

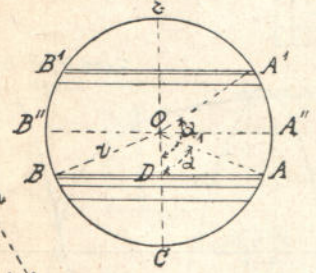

Черт. 190.

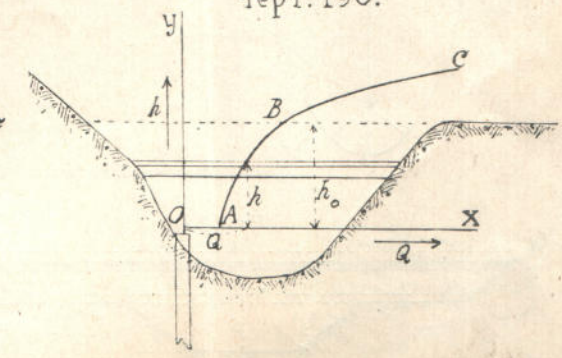

Черт. 195.

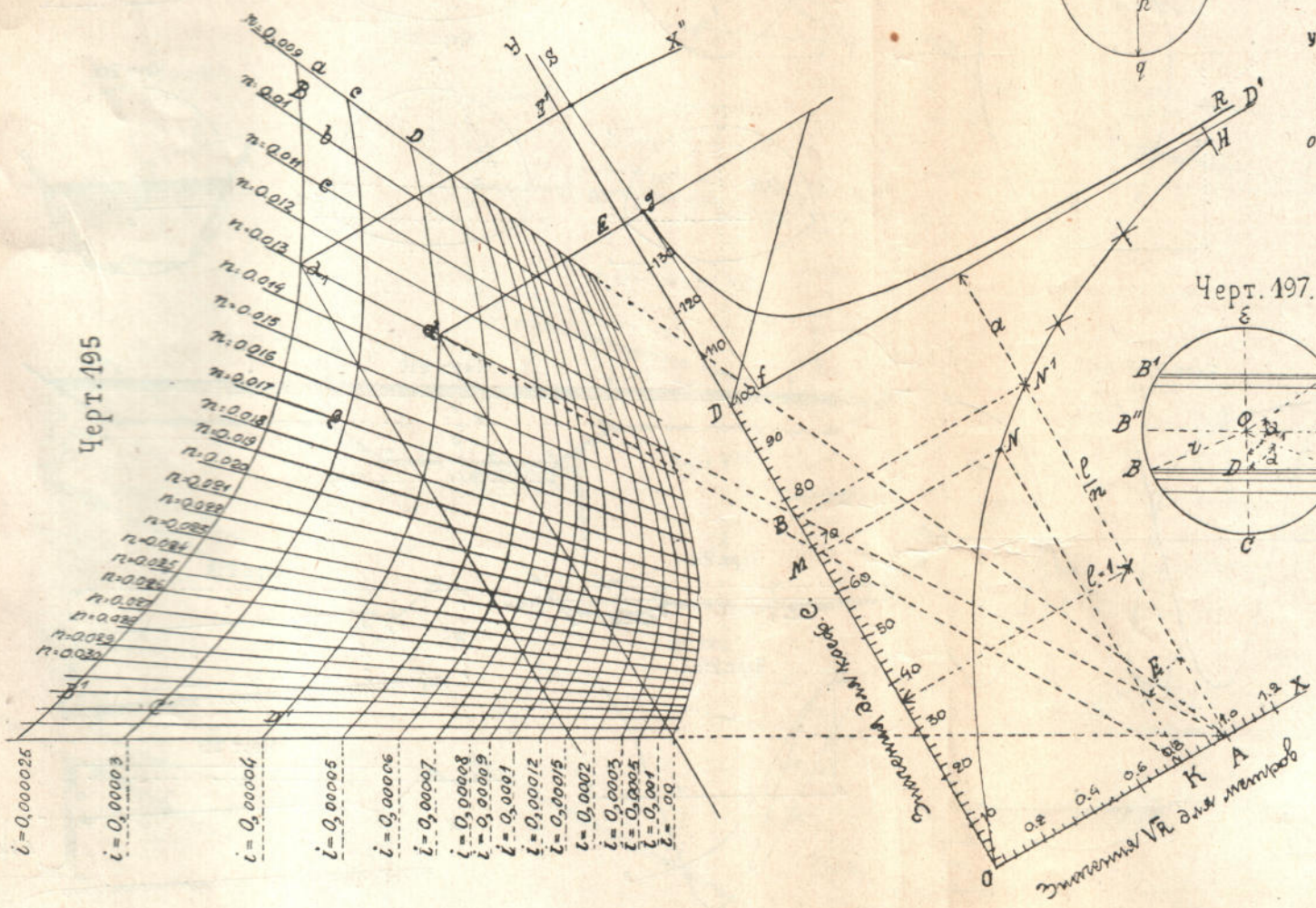

- $i = 0,000025$
- $i = 0,00003$
- $i = 0,00004$
- $i = 0,00005$
- $i = 0,00006$
- $i = 0,00007$
- $i = 0,00008$
- $i = 0,00009$
- $i = 0,0001$
- $i = 0,00012$
- $i = 0,00015$
- $i = 0,0002$
- $i = 0,0003$
- $i = 0,0005$
- $i = 0,0007$
- $i = 0,001$
- $i = 0,002$

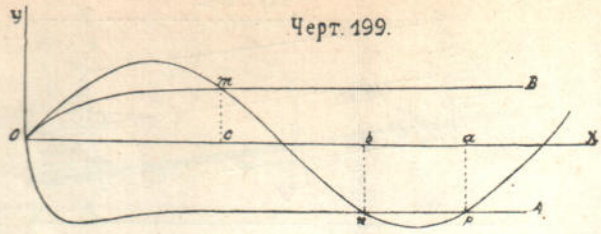

Черт. 199°

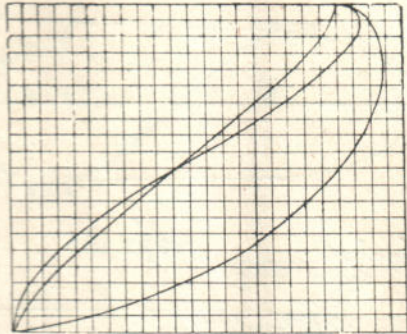

Черт. 201.

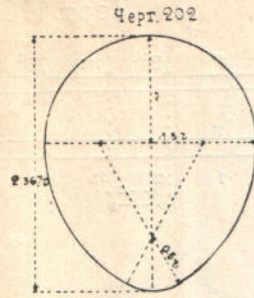
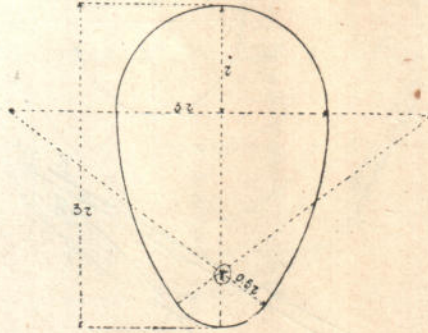

Черт. 203

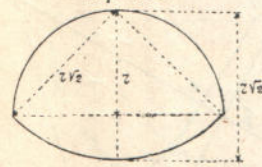

Черт. 205.

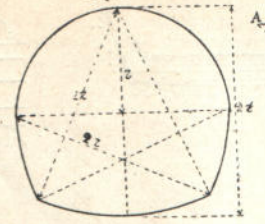

Черт. 206

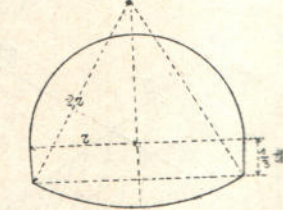

Черт. 204

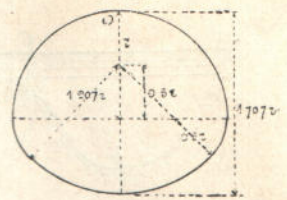

Черт. 212.

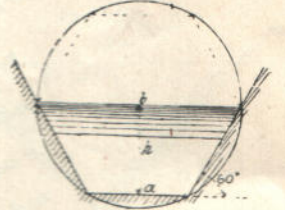

Черт. 208.

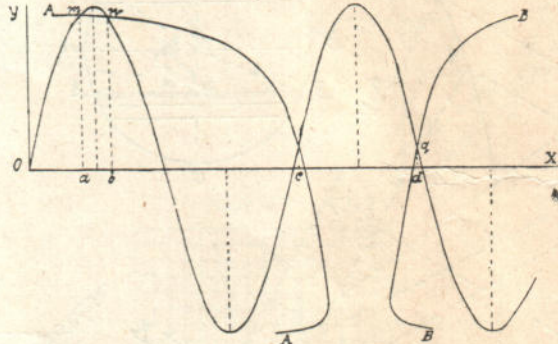

Черт. 216.

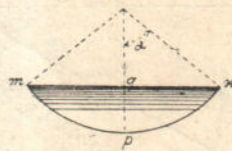

Черт. 210



Черт. 211

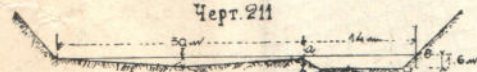

Черт. 215.

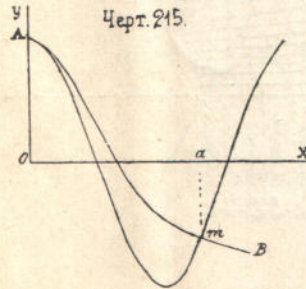

Черт. 218.

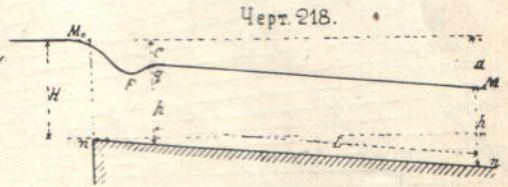

Черт. 219

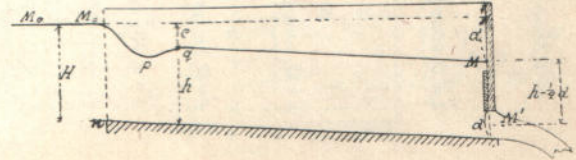

Черт. 209

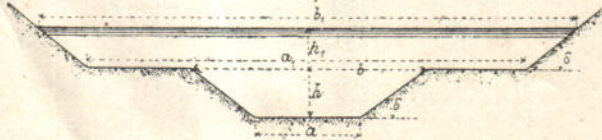

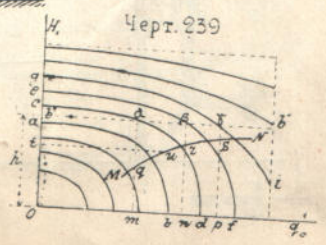
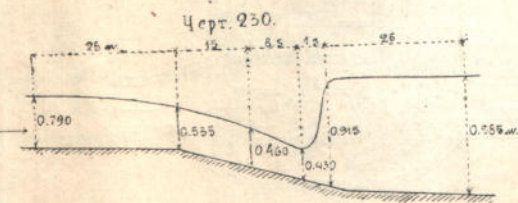
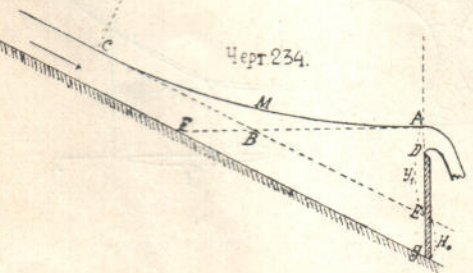
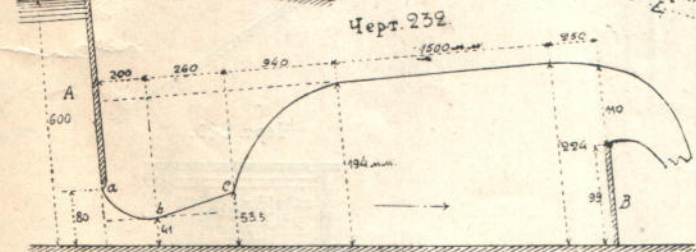
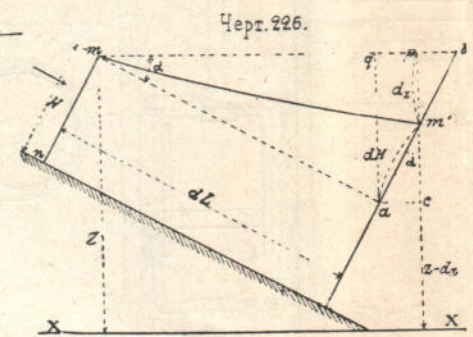
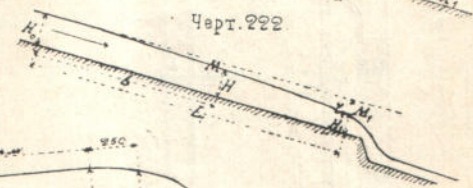
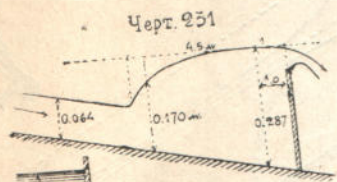
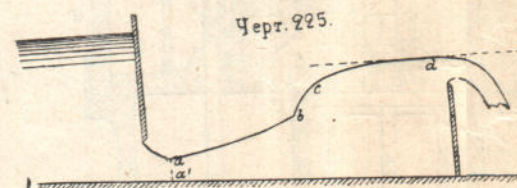
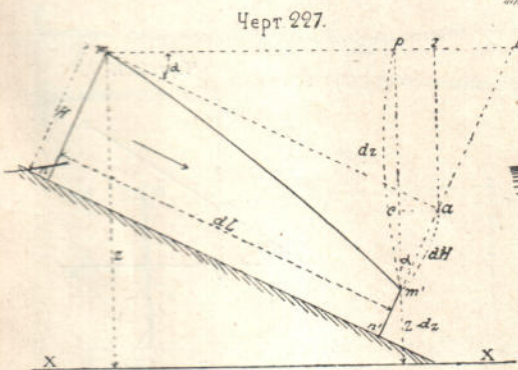
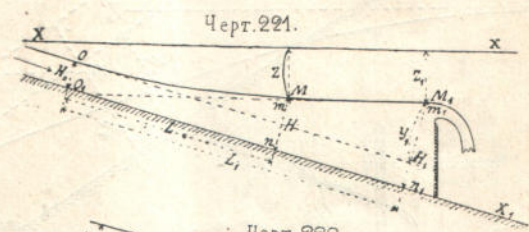
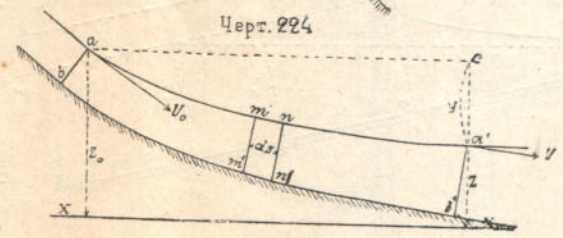
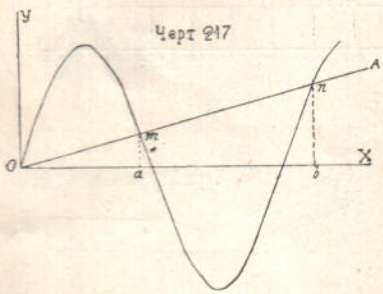
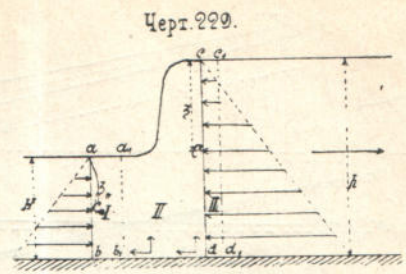
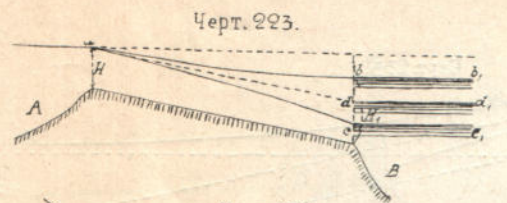
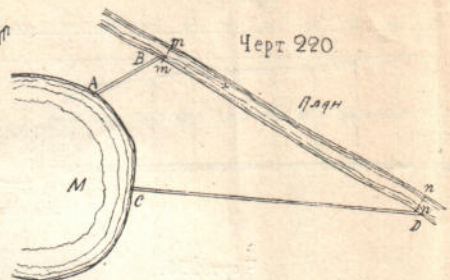
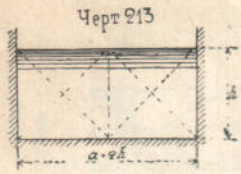

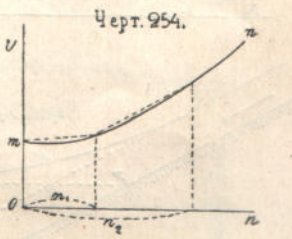
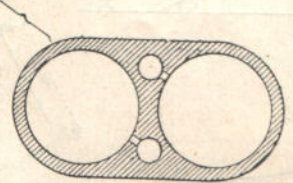
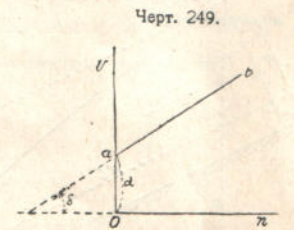
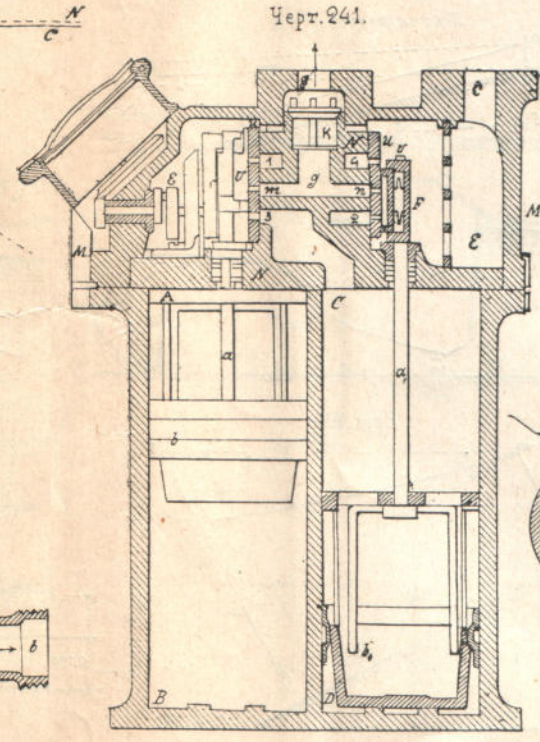
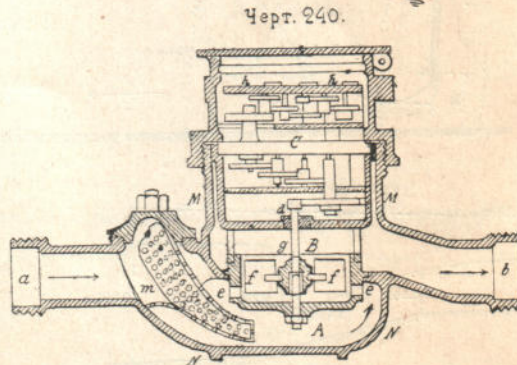
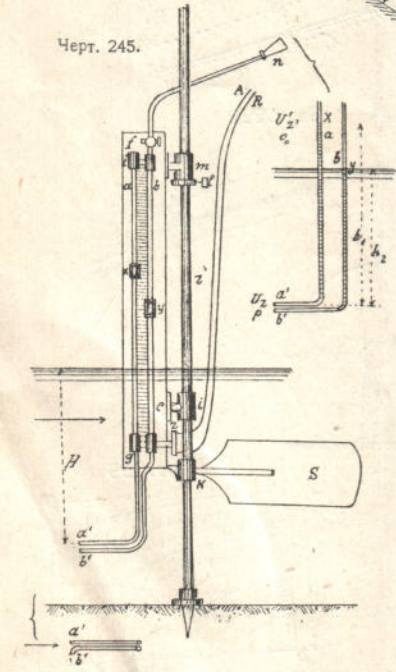
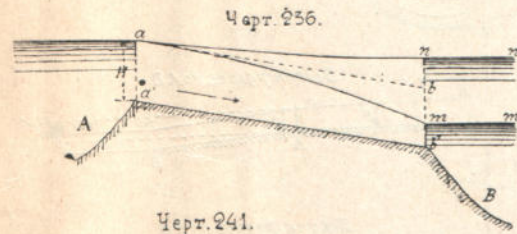
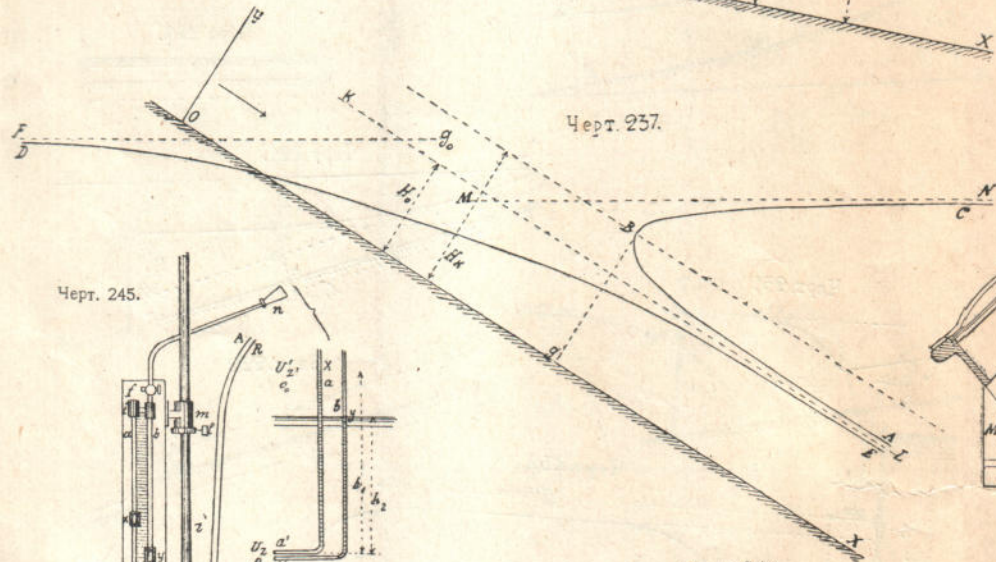
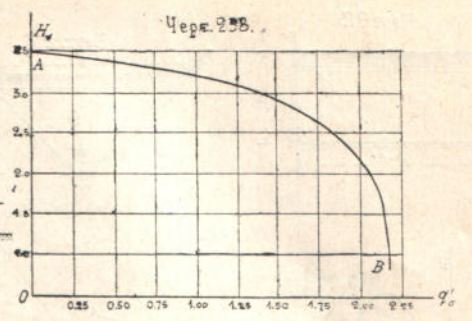
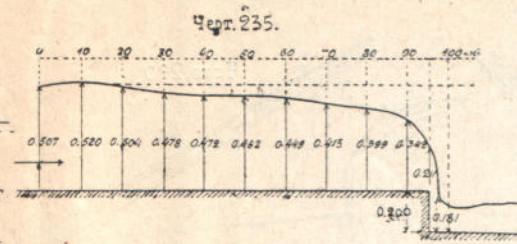
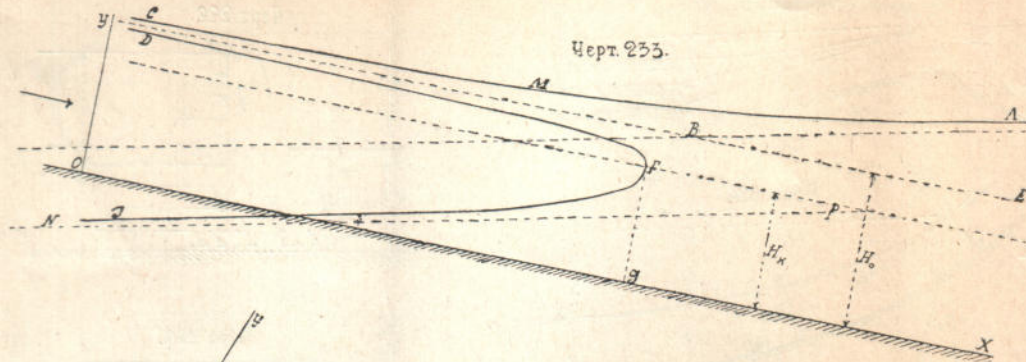

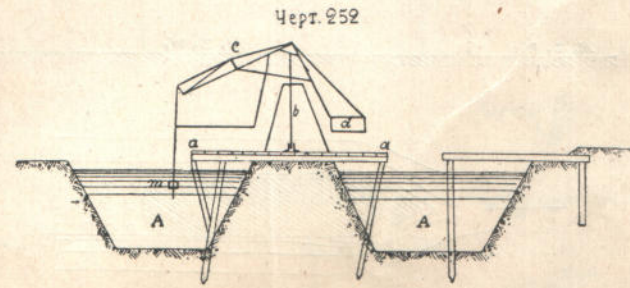
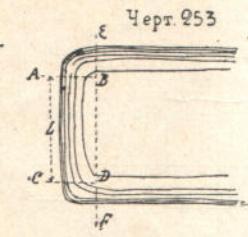
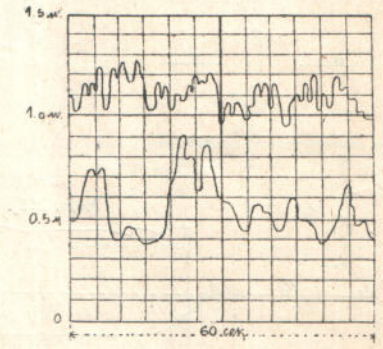
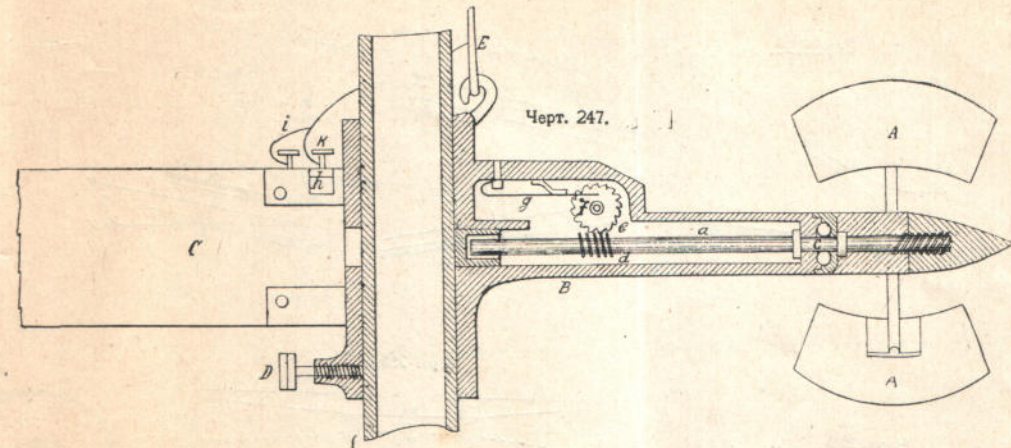
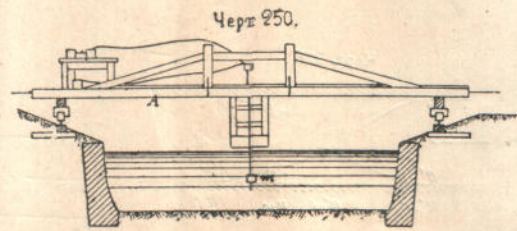
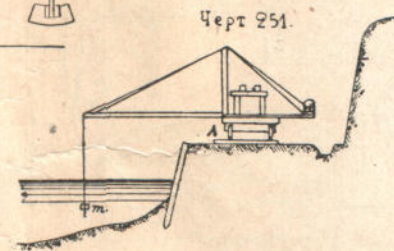
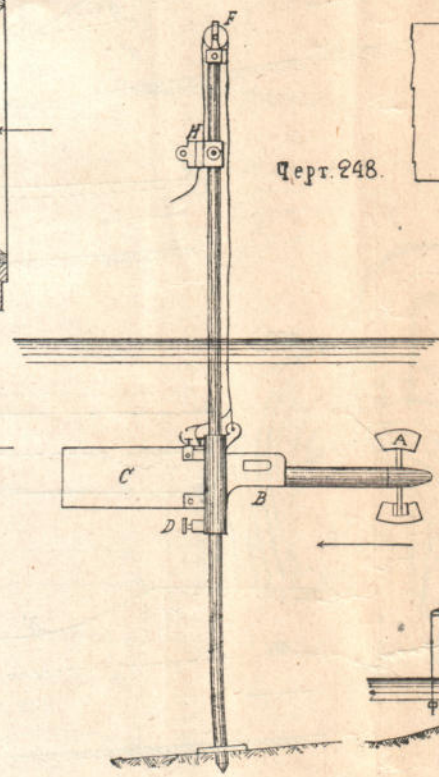
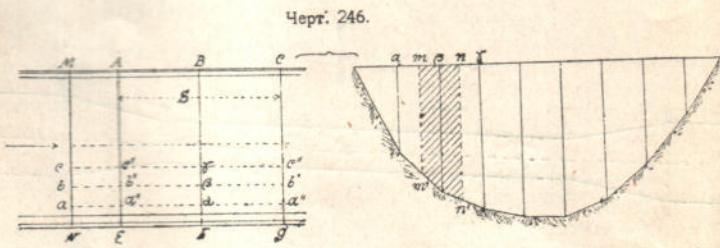
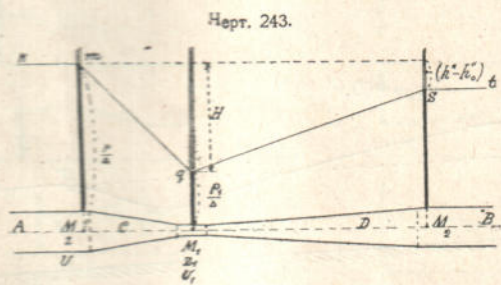
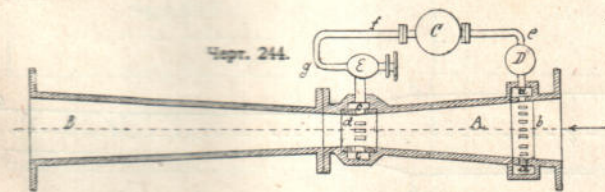
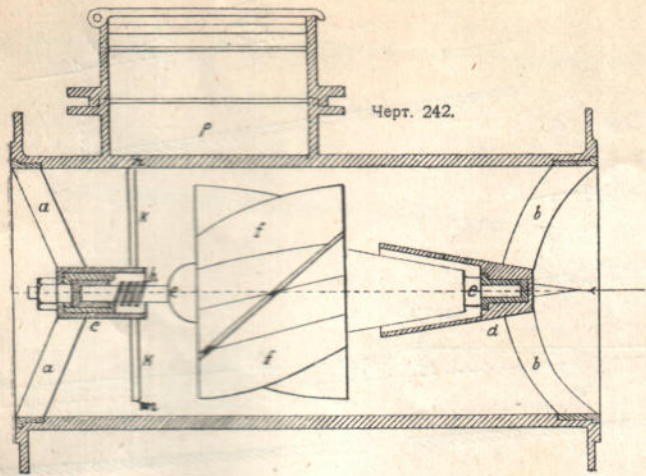

Черт. 255.

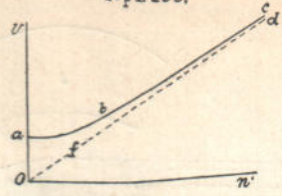

Черт. 256.

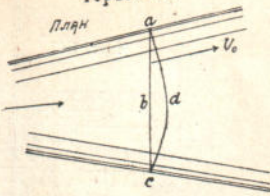

Черт. 257.

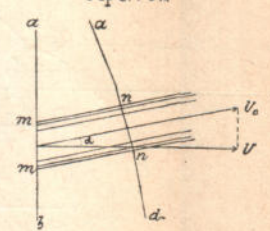

Черт. 258₁.

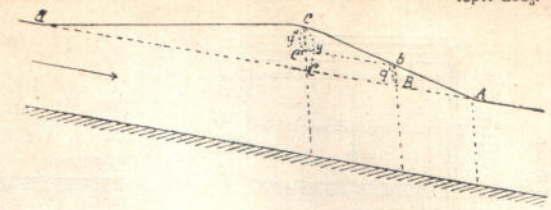
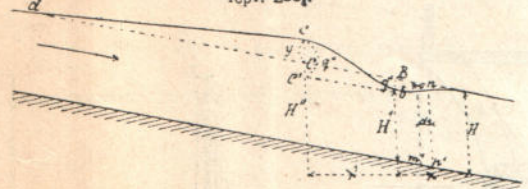

Черт. 259

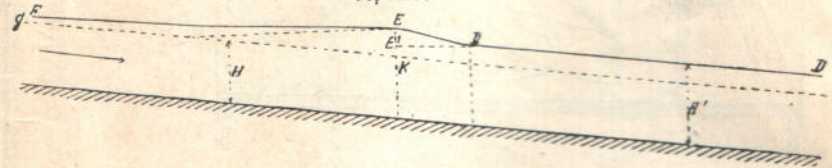

Черт. 258₁.

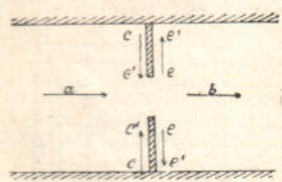

Черт. 258₂.

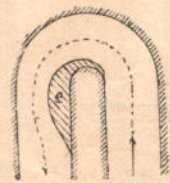
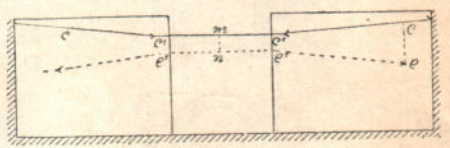

Черт. 260.

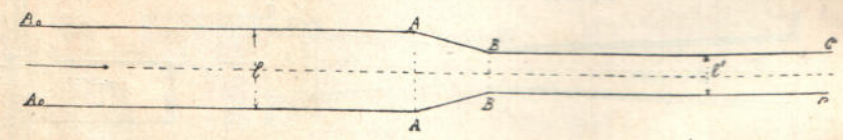

Черт. 258₃.

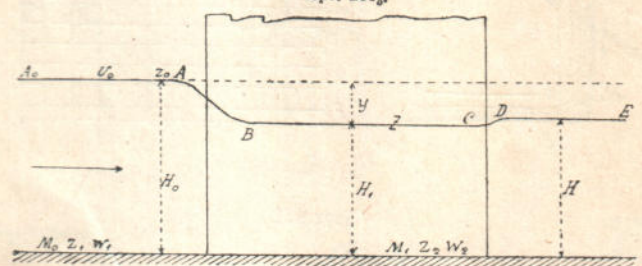

Черт. 262.

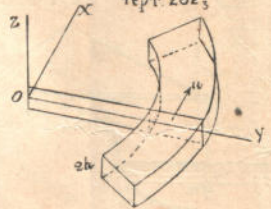

Черт. 260.

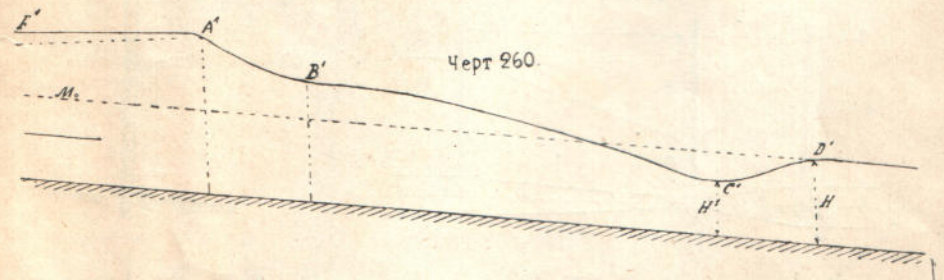

Черт. 258₄.

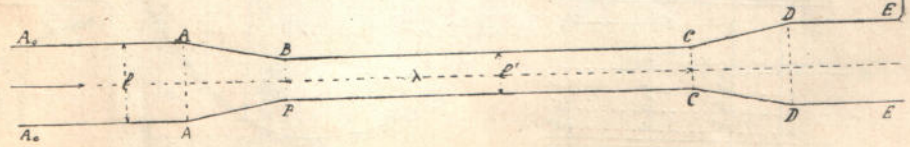
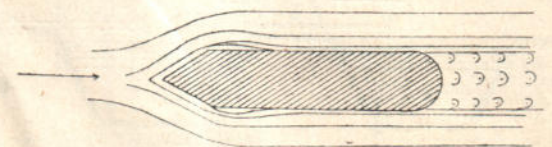
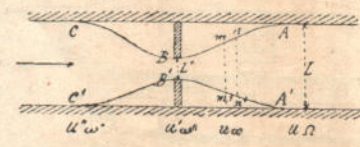

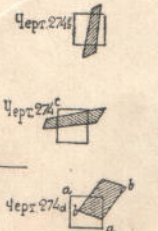
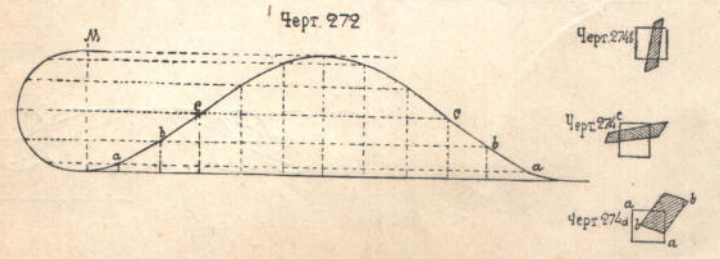
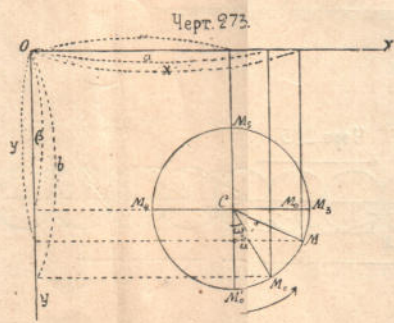
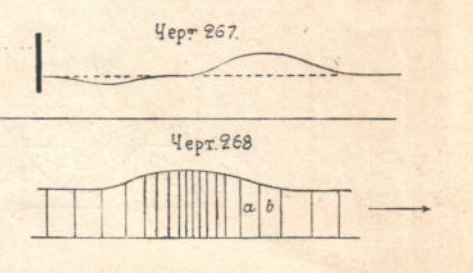
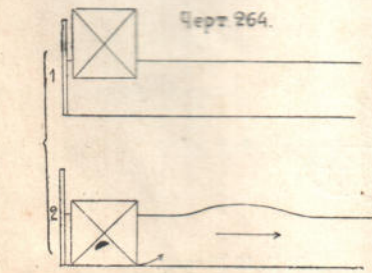
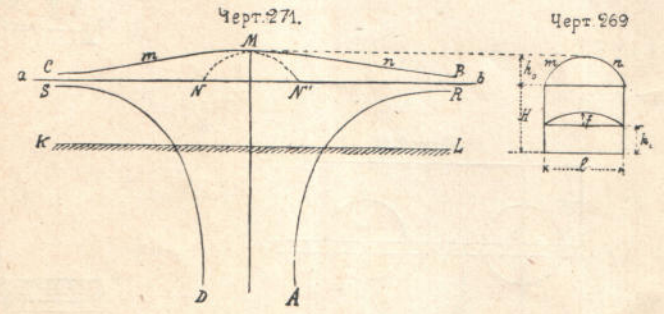
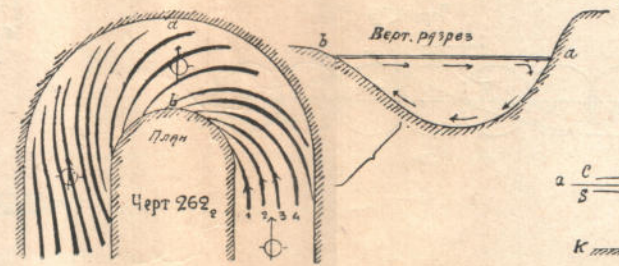
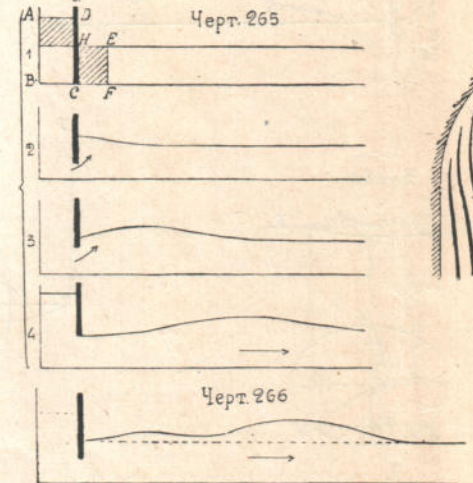
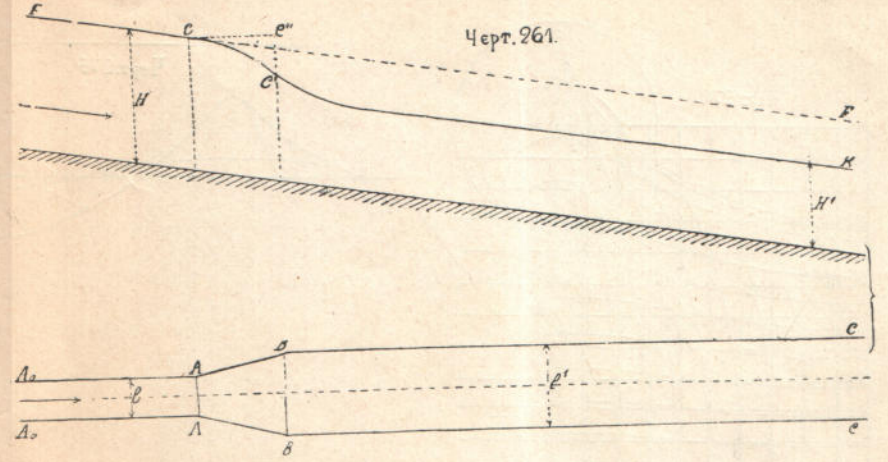
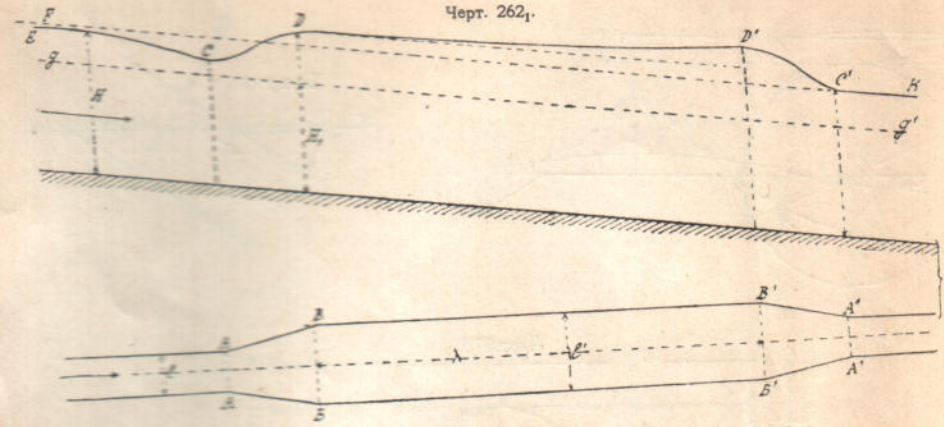

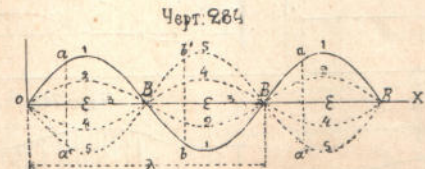
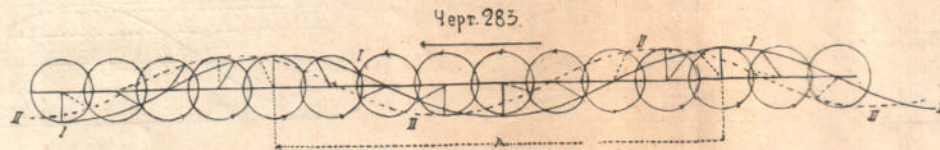
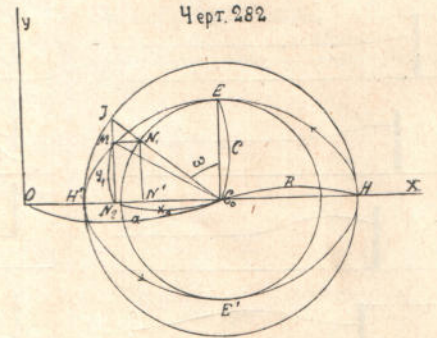
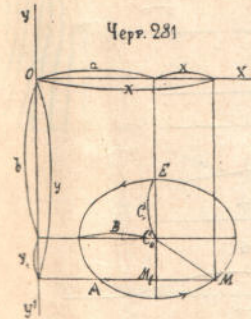
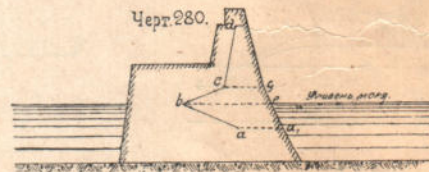
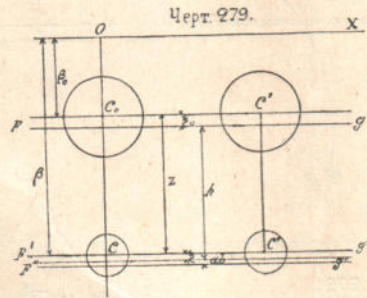
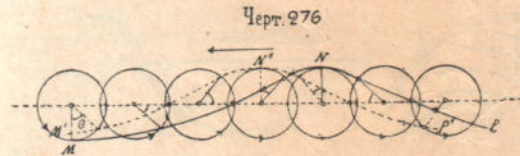
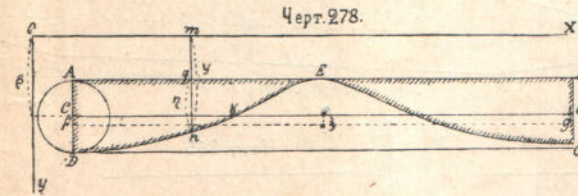
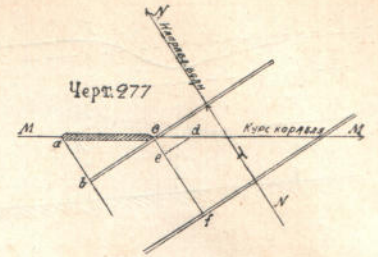
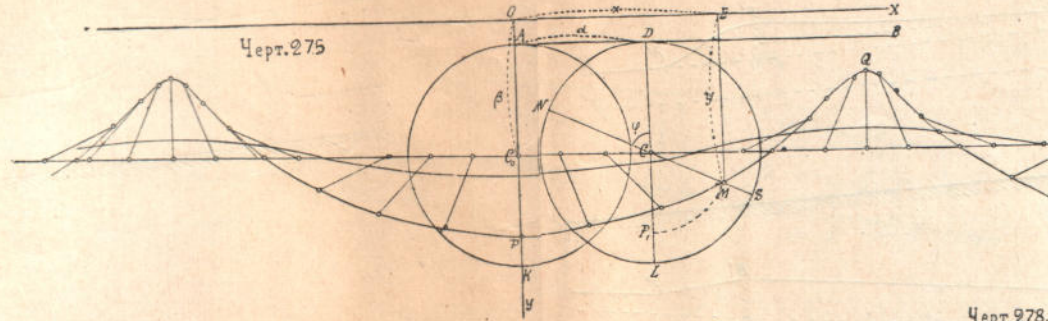
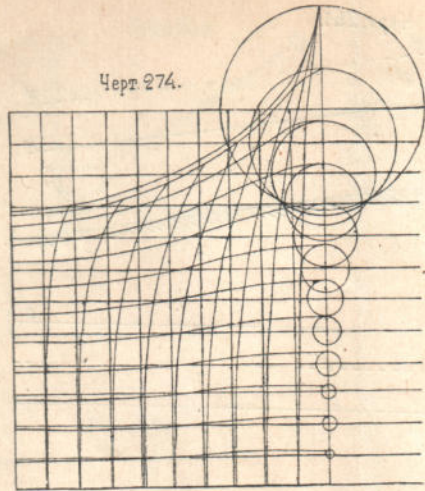

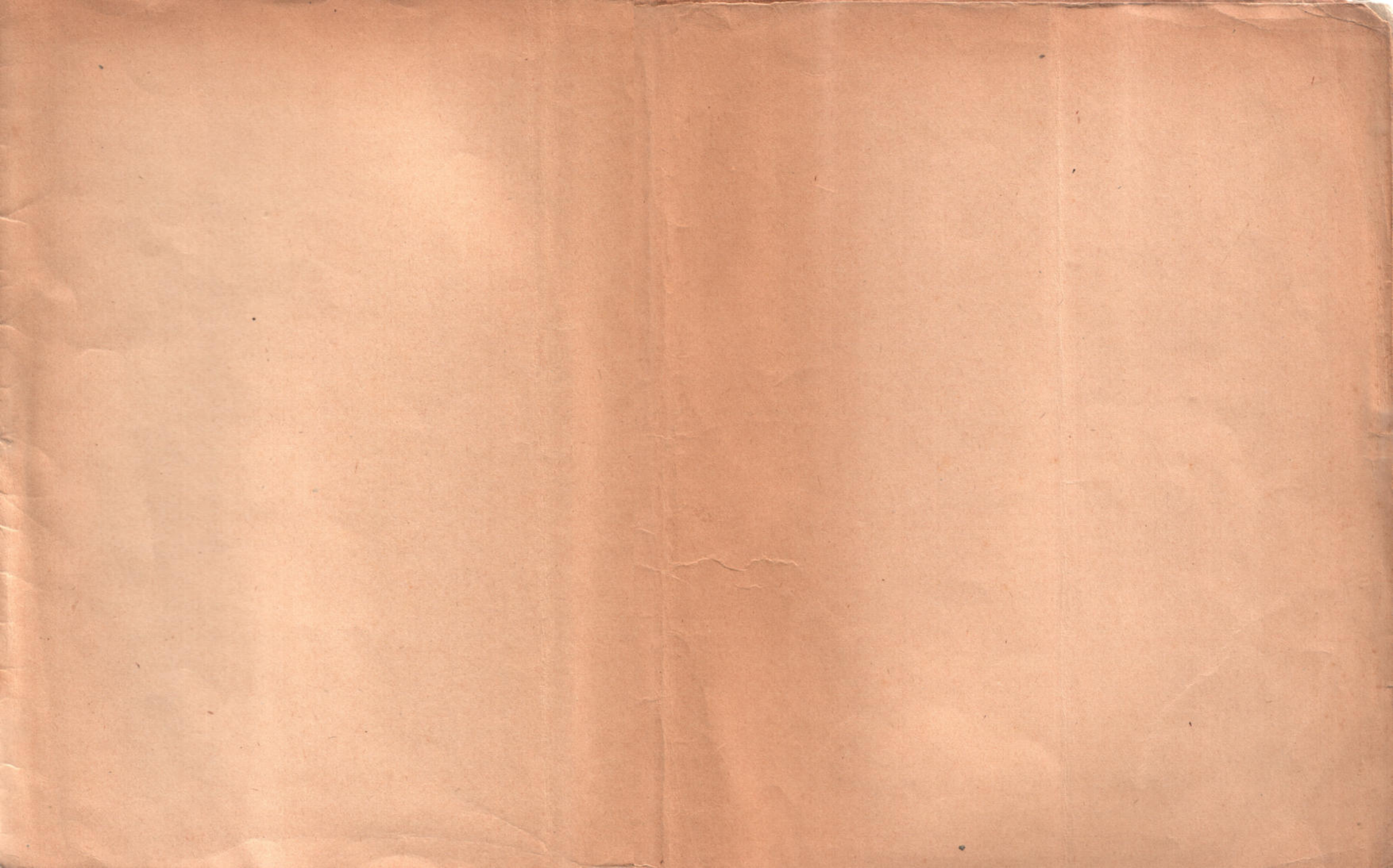

532

M-17