

Ministry of Education and Science of Ukraine
National University of Water and Environmental Engineering
Department of Architectural Design Bases, Construction and Graphics

03-07-93M

METHODICAL GUIDELINES
and tasks to a practical training and independent work
IN THE DISCIPLINE
«DESCRIPTIVE GEOMETRY»
PART 3. AXONOMETRY
for higher education students of the first (bachelor) level
in the field of study 191 «Architecture and Urban planning»
of full-time education form

МЕТОДИЧНІ ВКАЗІВКИ
та завдання до практичних занять і самостійної роботи
З НАВЧАЛЬНОЇ ДИСЦИПЛІНИ
«НАРИСНА ГЕОМЕТРІЯ»
ЧАСТИНА 3. АКСОНОМЕТРІЯ
для здобувачів вищої освіти першого (бакалаврського) рівня
за спеціальністю 191 «Архітектура та містобудування»
денної форми навчання

Recommended
by the scientific and methodical
quality council of ERICEA
Protocol № 8 18.04.2023

Rivne – 2023

Methodical guidelines and tasks to a practical training and independent work in the discipline «Descriptive Geometry» for higher education students of the first (bachelor) level in the field of study 191 «Architecture and Urban planning» of full-time education form. Part 3. Axonometry [Electronic publishing] / Pugachov E. V., Litnitskyi S. I., Kundrat T. M. – Rivne : NUWEE, 2023. – 31 p.

Developers:

Pugachov E. V., Doctor of Technical Sciences, Professor,

Litnitskyi S. I., Ph.D., Associate Professor,

Kundrat T. M., Ph.D., Associate Professor

of the Department of Architectural Design Bases, Construction and Graphics.

Head of the Department: Romashko V. M., Doctor of Technical Sciences, Professor

Head of the support group
in the field of study 191
«Architecture and Urban planning»

Doctor of Architecture,
Professor, Myhailyshyn O. L.

CONTENTS

INTRODUCTION.....	3
1. QUESTIONS FOR INDEPENDENT TRAINING	3
2. CONSTRUCTION OF AXONOMETRY OF THE HOUSE.....	4
3. LITERATURE	31

INTRODUCTION

Methodical guidelines and tasks to a practical training and independent work are developed according to the syllabus of the course for higher education students of the first (bachelor) level in the field of study 191 “Architecture and Urban planning” of full-time education form.

The purpose of a practical training is fixing of theoretical knowledge, acquisition of skills of creation of an axonometry and also development of spatial imagination by correlation of orthogonal projections of a geometrical object (task) and their axonometrical images.

Methodical guidelines contain questions for independent preparation, a task (26 options of buildings in orthogonal projections), short methodical recommendations about their performance and the list of references.

Tasks are performed by a pencil in A3 format. The constructed axonometry are distinguished with the reinforced line a soft pencil. Auxiliary constructions are shown with a thin line with a firm pencil. Shadows are represented by dot graphics. The results of the completed tasks are used to monitor current progress and admission to examinations.

1. QUESTIONS FOR INDEPENDENT TRAINING

1. What is the purpose of building axonometric images of architectural objects?
2. Explain the terms "rectangular axonometrical projections" and "oblique-angled axonometrical projections".
3. Explain terms "distortion indicators for axes of coordinates" and "the given distortion indicators".
4. Give definition to isometric, dimetric and trimetric axonometrical projections.
5. Formulate the main theorem of an axonometry.
6. What standard axonometrical projections do you know?
7. Why in standard axonometrical projections a geometrical object looks increased?
8. What standard axonometrical projection is considered the most evident?
9. How the direction of a light ray at creation of shadows in an axonometry is set?

Literature: 1 (pp. 139-153, 191), 2 (pp. 153-163), 3 (pp. 191-204), 4(pp. 107-119), 5 (pp. 135-147, 162-216), 6 (pp. 219-244), 7 (pp. 171-187).

2. CONSTRUCTION OF AXONOMETRY OF THE HOUSE

Task: based on the orthogonal projections of the house, construct its given axonometric image and its own and falling shadows.

Basic data are given in table 1 and in figures 1-26.

Table 1

Task	Axonometric projection	Task	Axonometric projection
1	Dimetric projection	14	Isometric projection
2	Isometric projection	15	Dimetric projection
3	Isometric projection	16	Isometric projection
4	Dimetric projection	17	Isometric projection
5	Isometric projection	18	Dimetric projection
6	Dimetric projection	19	Isometric projection
7	Isometric projection	20	Dimetric projection
8	Isometric projection	21	Isometric projection
9	Isometric projection	22	Isometric projection
10	Dimetric projection	23	Isometric projection
11	Isometric projection	24	Dimetric projection
12	Isometric projection	25	Isometric projection
13	Isometric projection	26	Isometric projection

Methodical guidelines: *a)* to redraw orthogonal projections of the building and to complete them, having defined points of intersection of unfinished edges with the planes of sides; *b)* rationally tie the house to the coordinate axes, taking into account the planes of symmetry of the house; *c)* in the increased scale (1.5-2 times) to construct a building plan axonometry (including a tower and its roof, the main roof); *d)* the direction of the sun's beams during the construction of shadows is chosen in such a way as to reveal the shape of the house, and the shadow falling on the ground remained within the limits of the sheet; *e)* for creation of shadows from a tower and its roof falling on the main roof it is necessary to use the shadows of these objects falling to the ground, returning on a roof of a point of intersection of shadows of the corresponding edges in the direction of the return ray.

Task 1

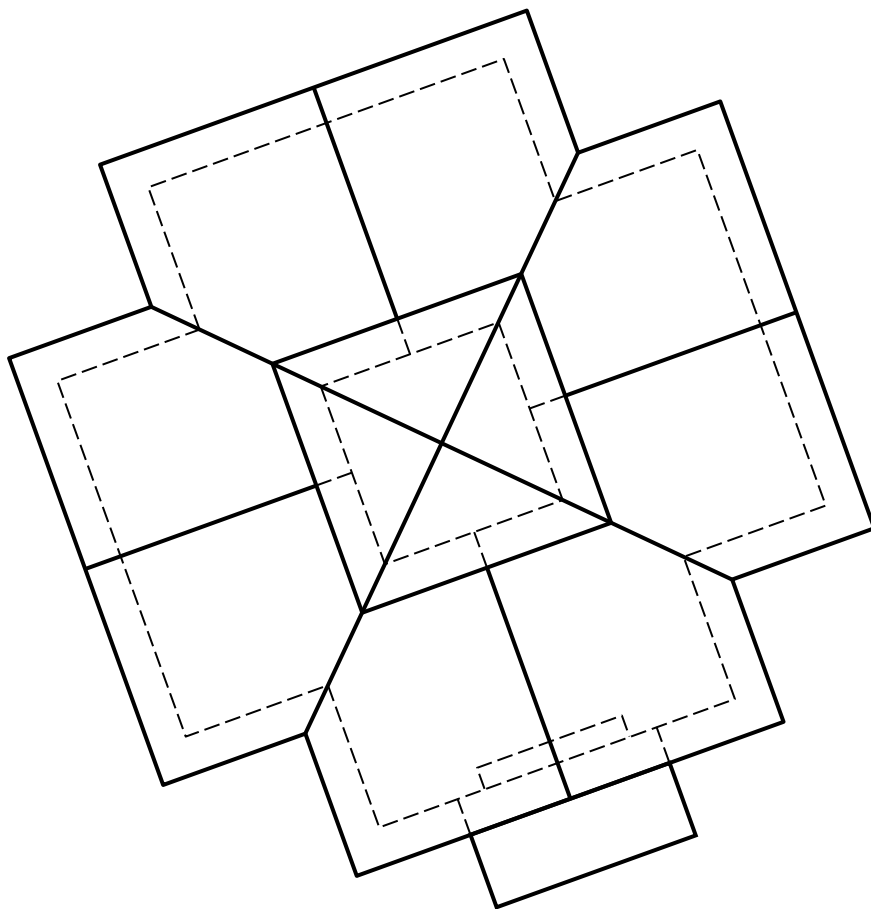
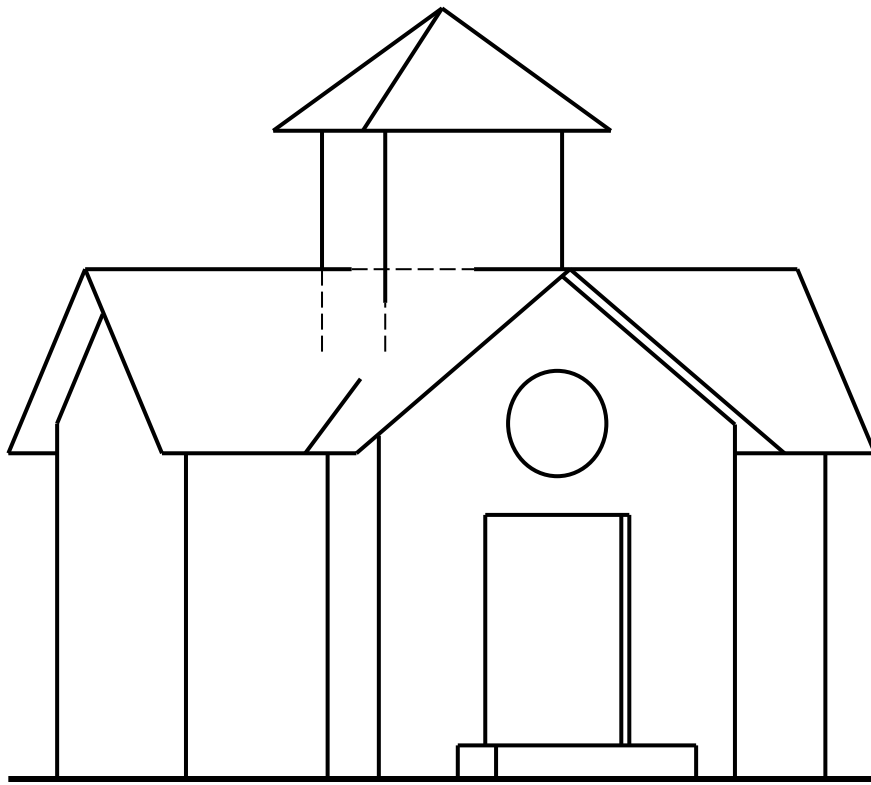

Task 2

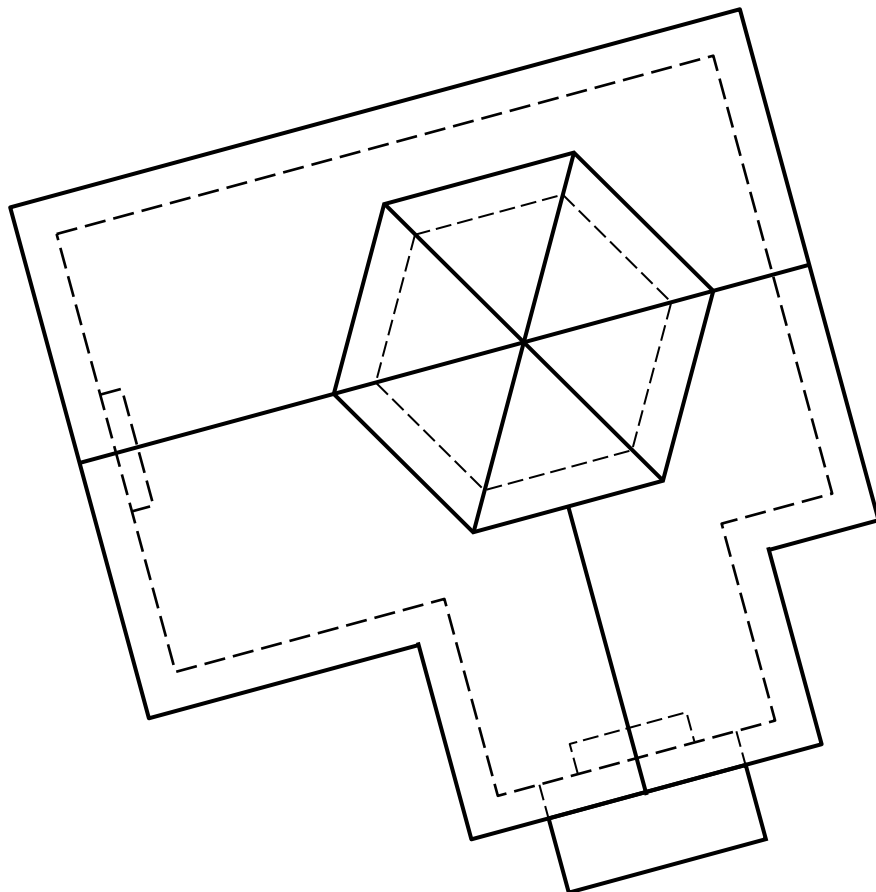
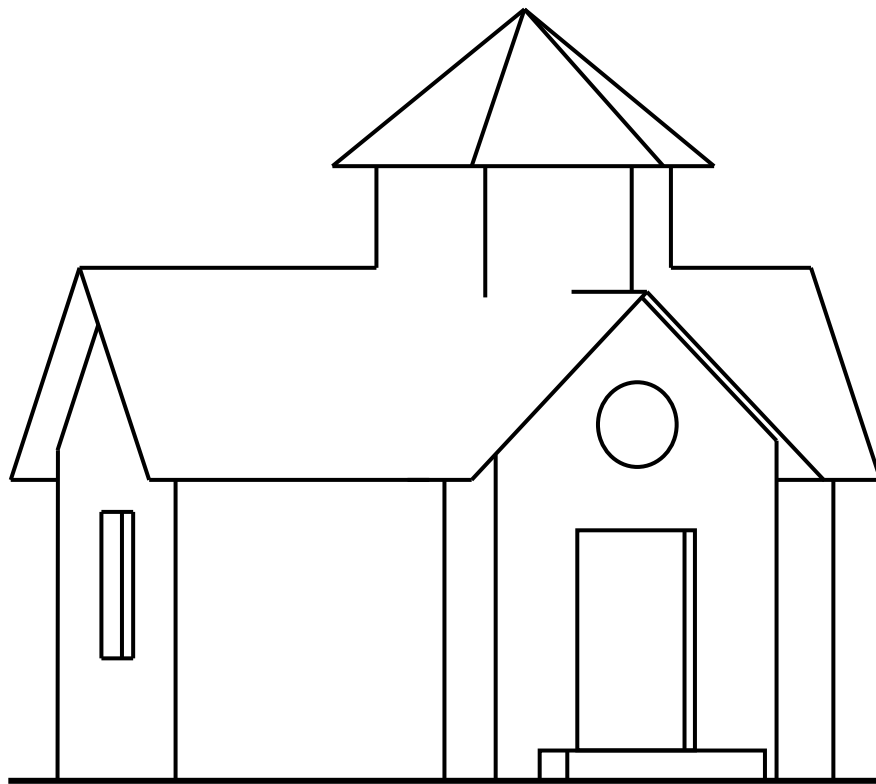

Task 3

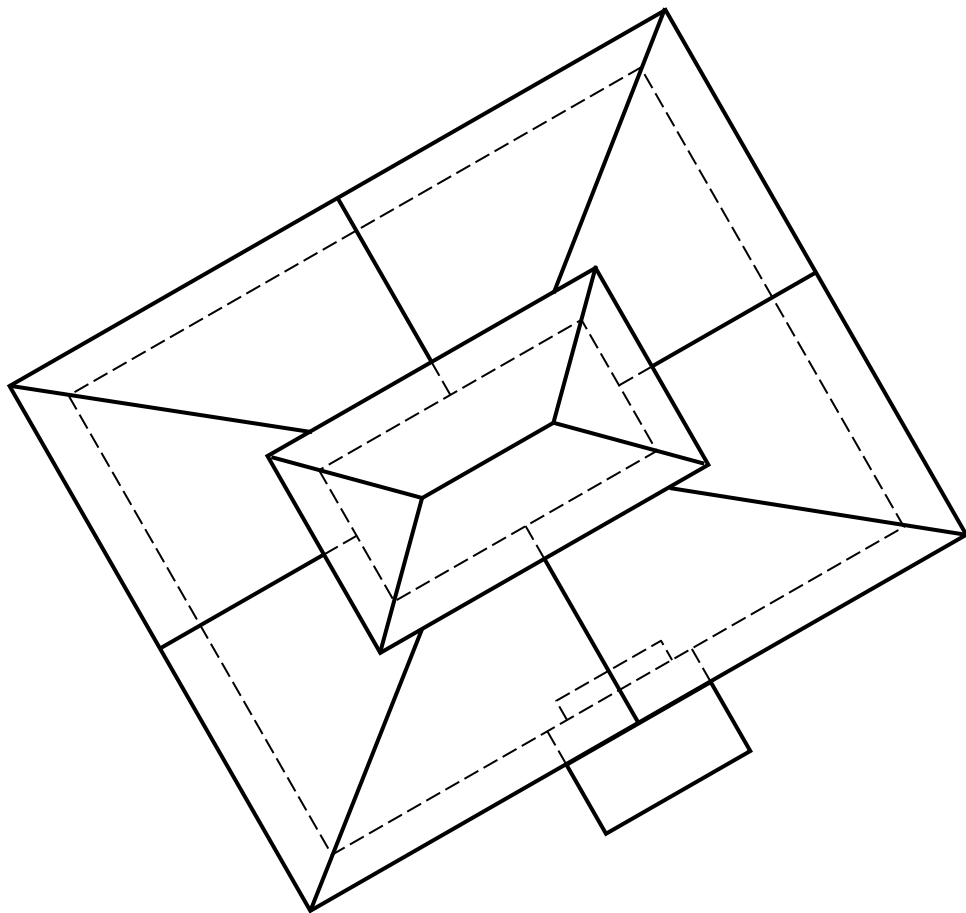
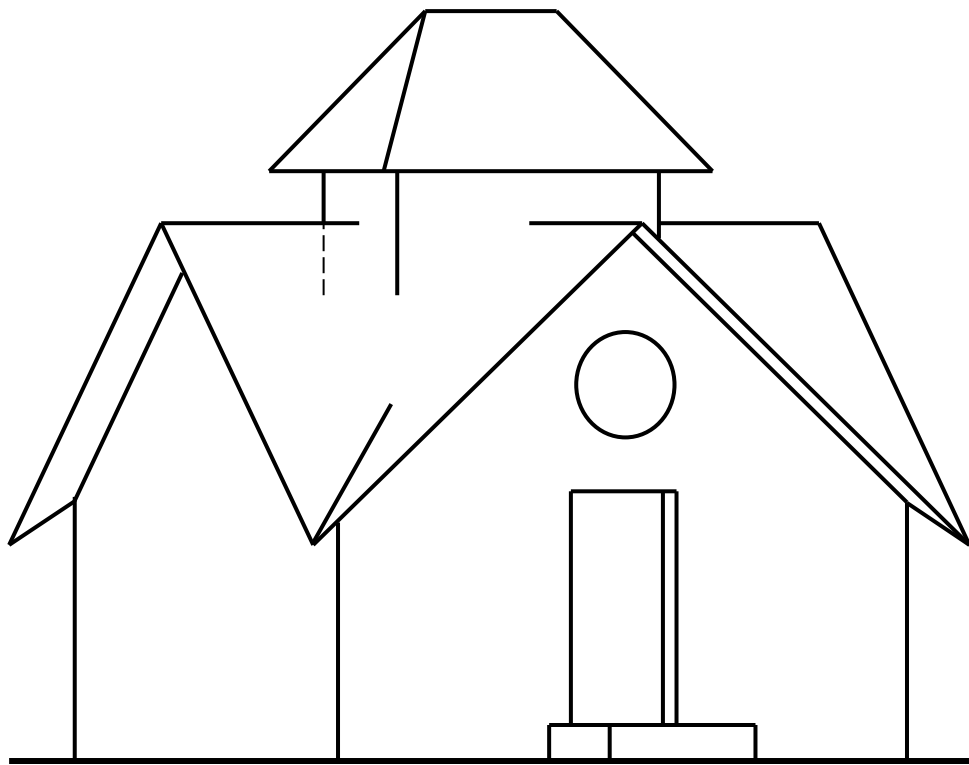

Task 4

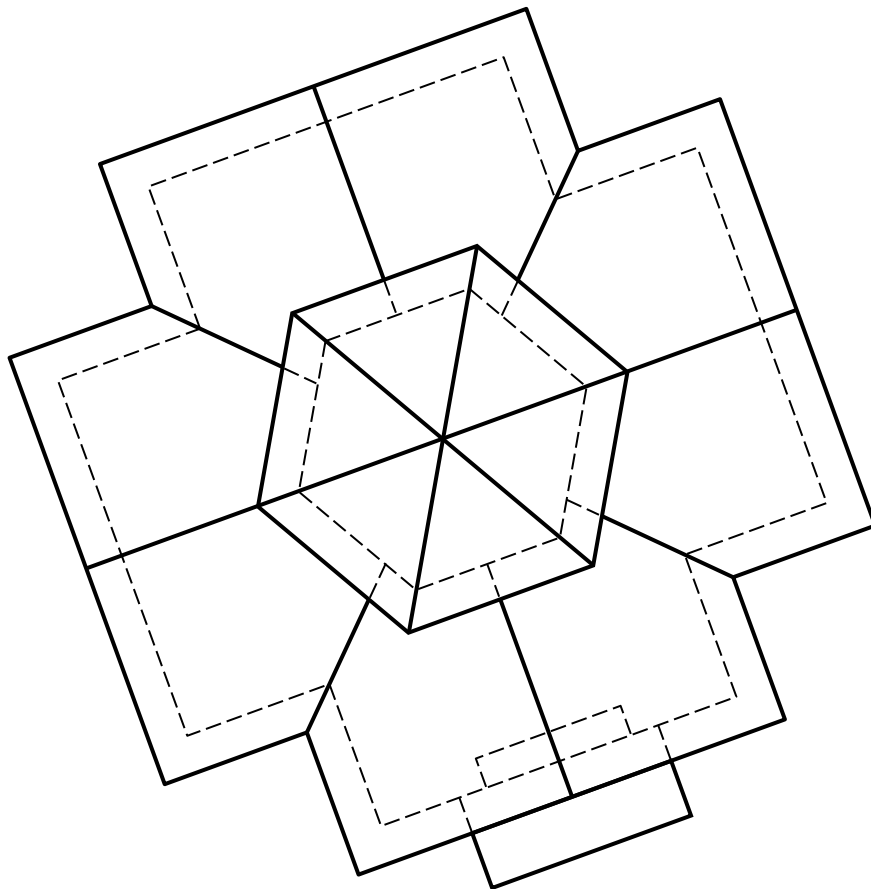
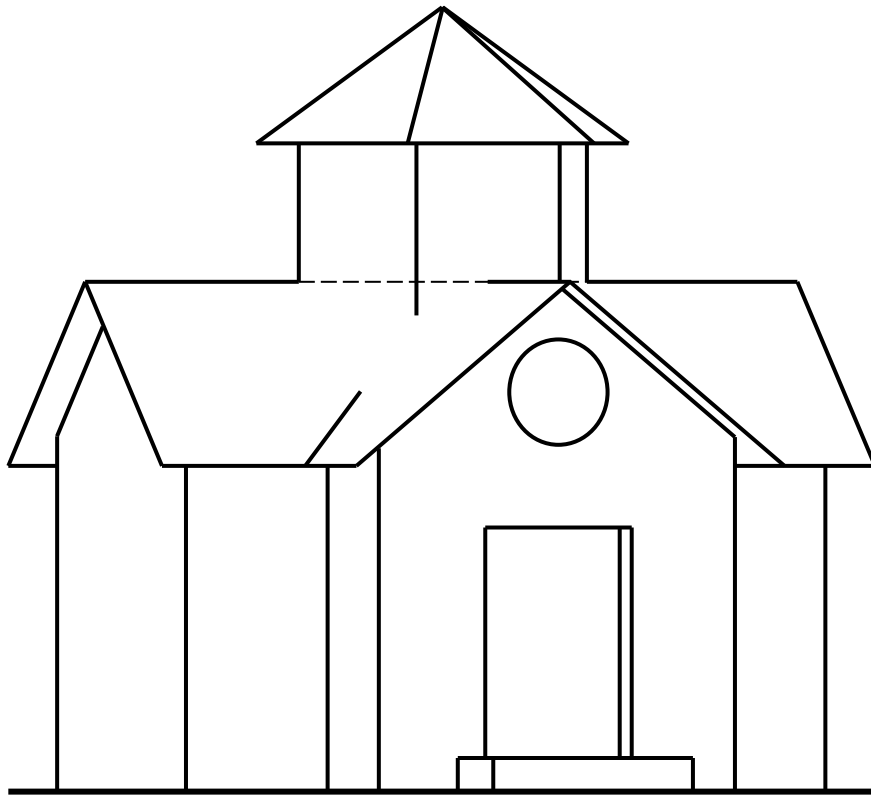

Task 5

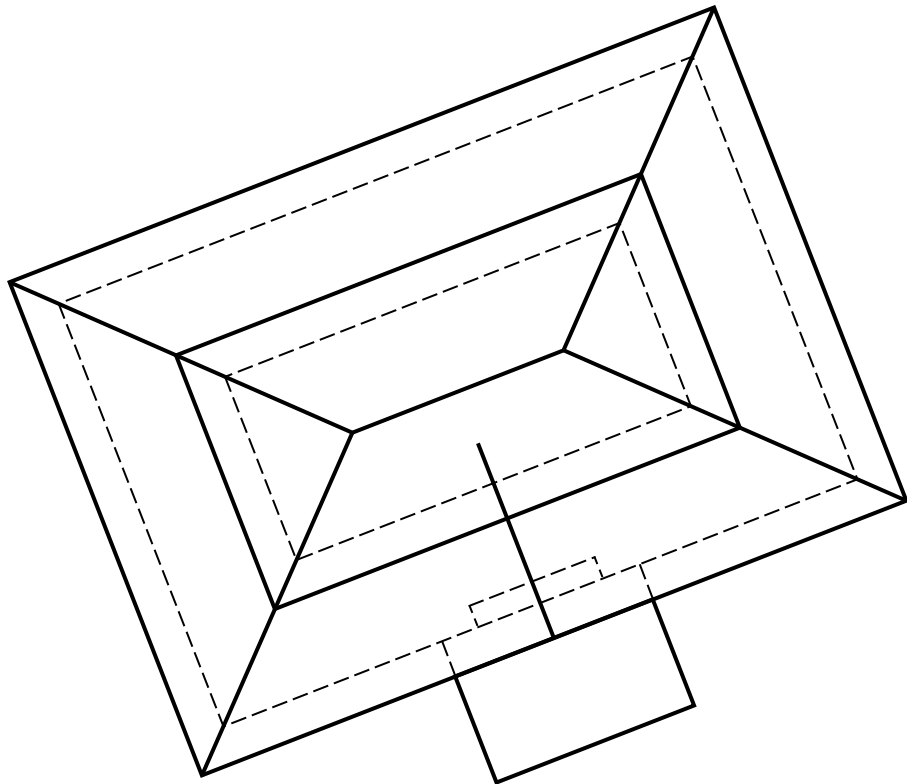
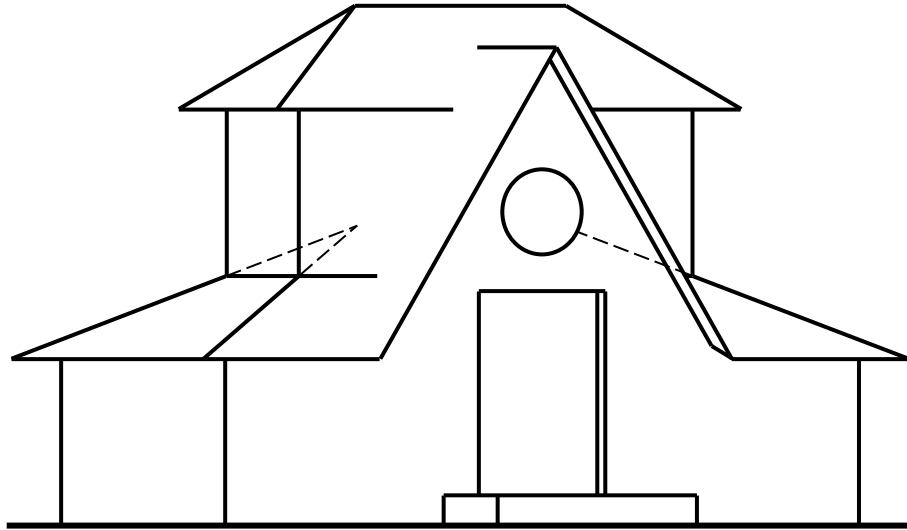

Task 6

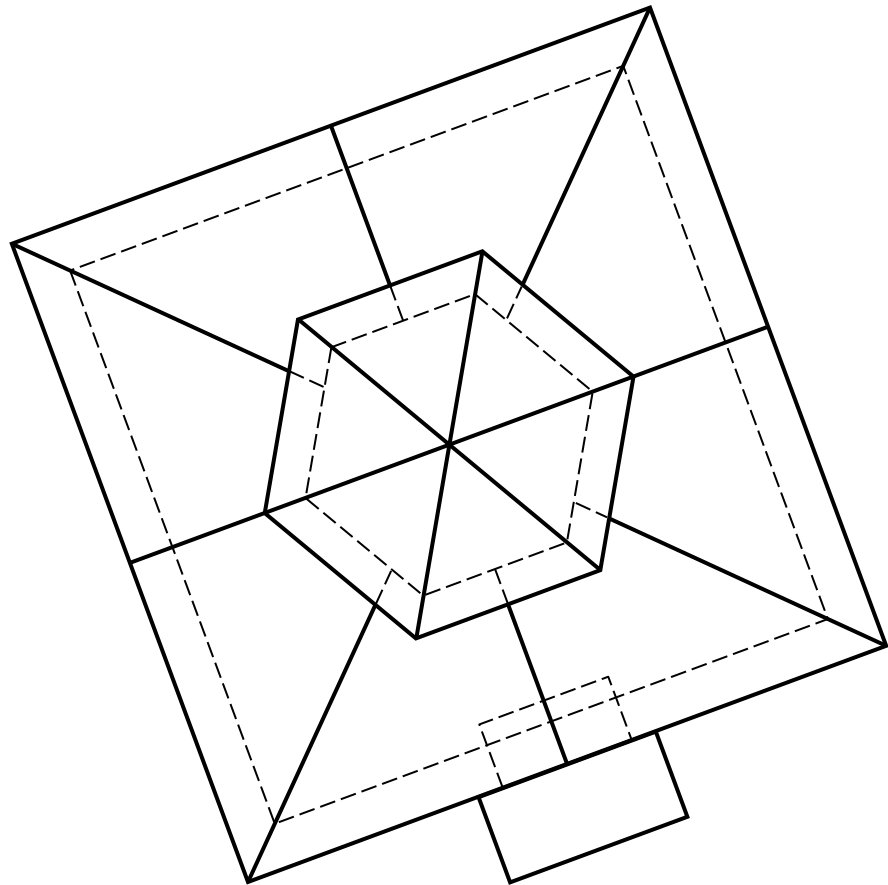
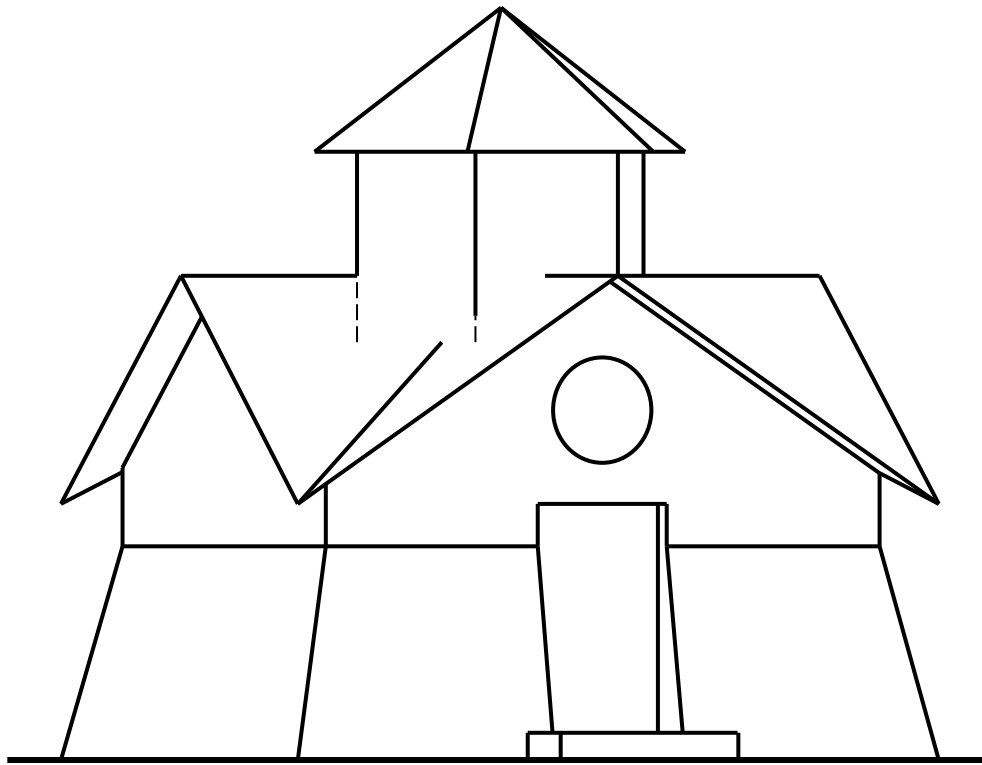

Task 7

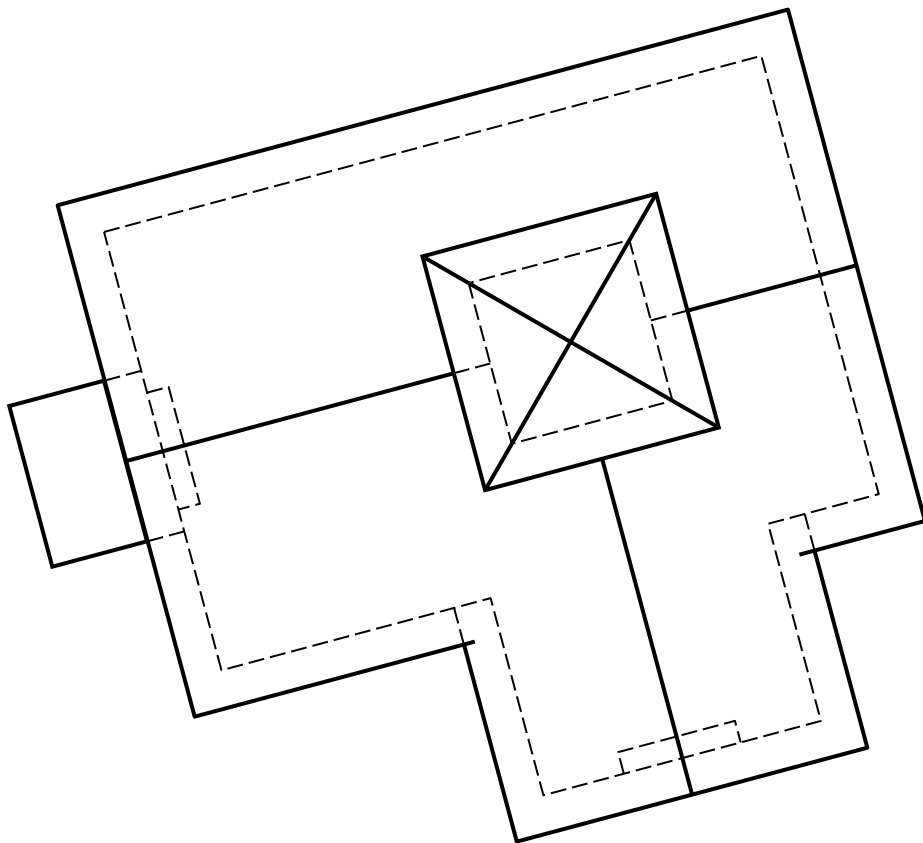
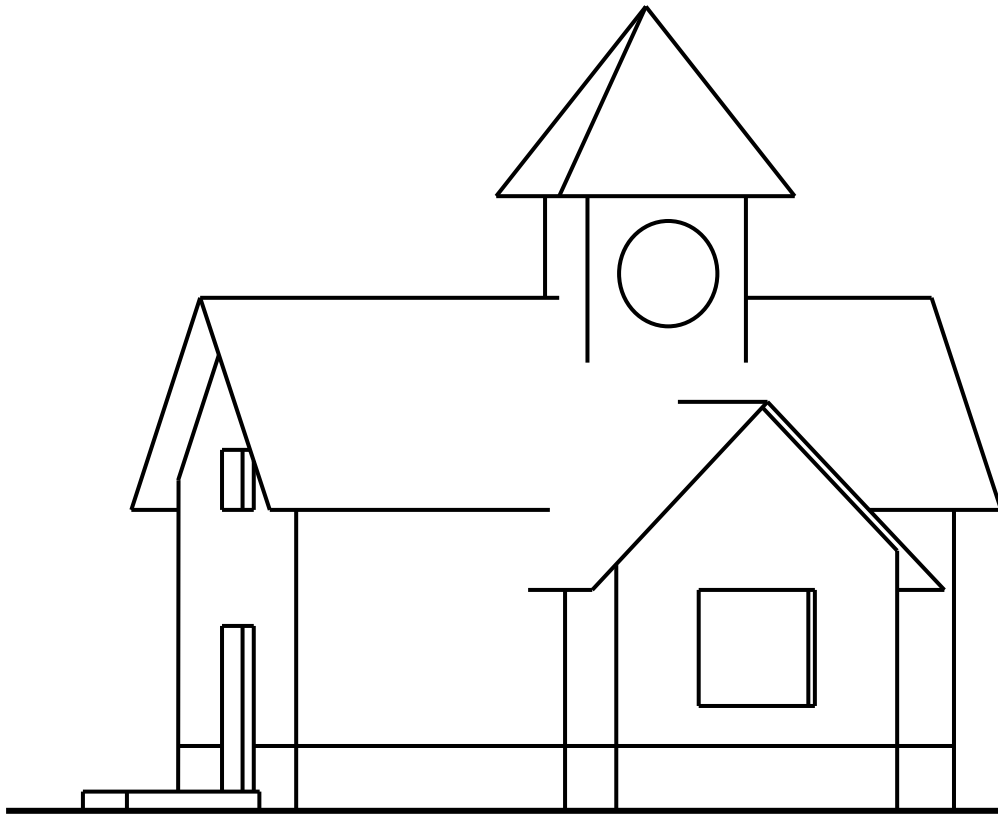

Task 8

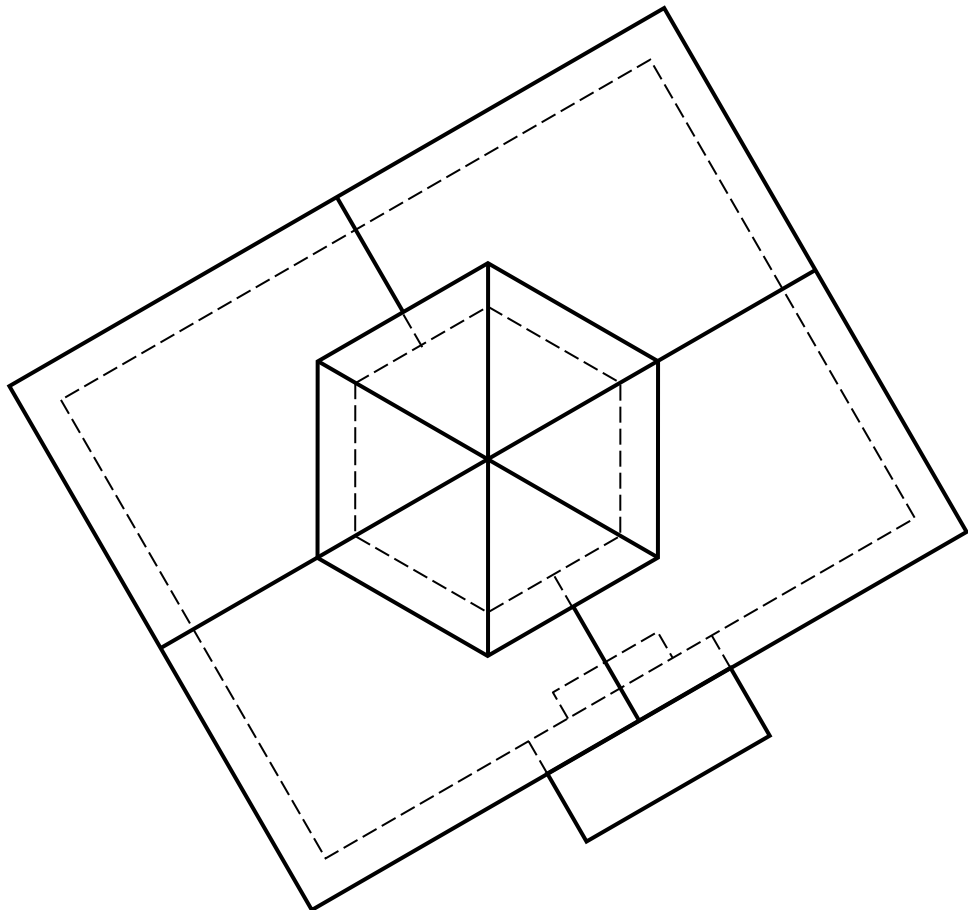
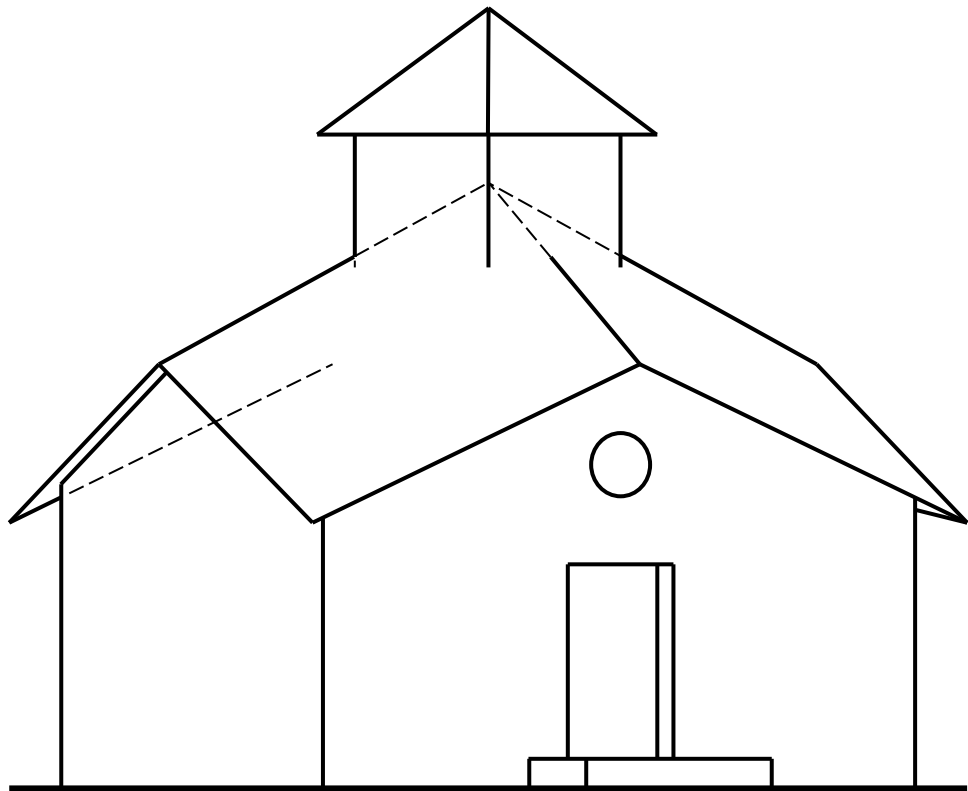

Task 9

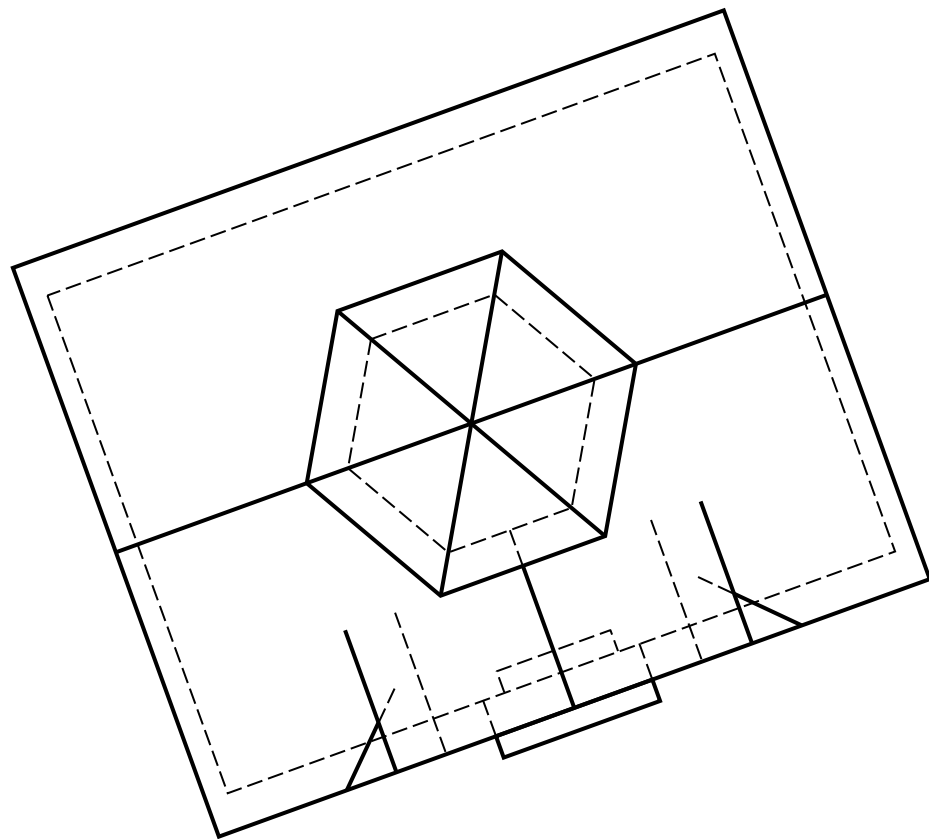
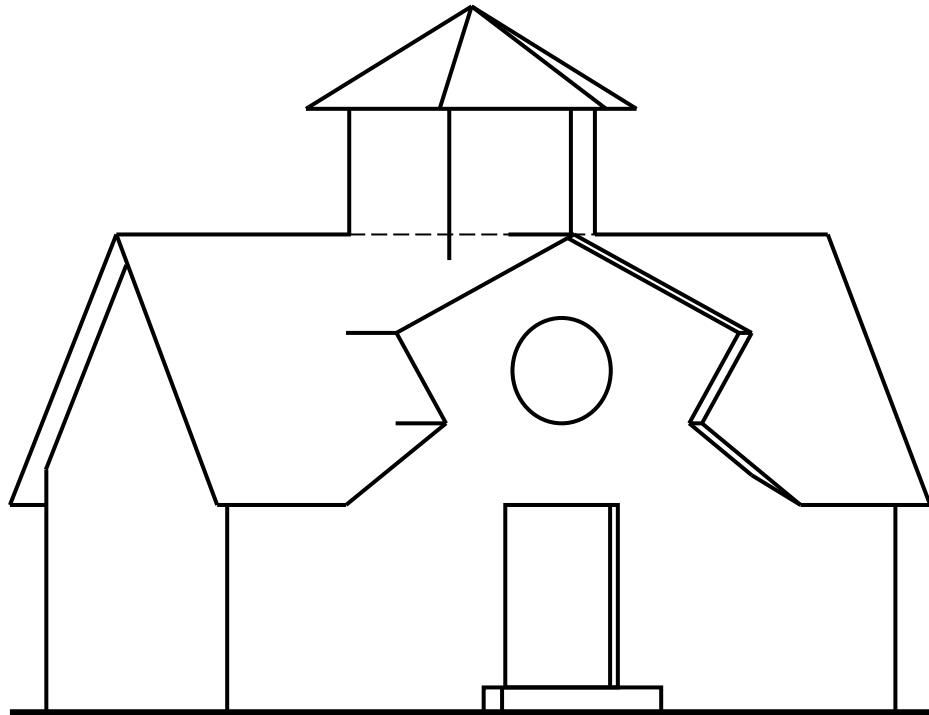

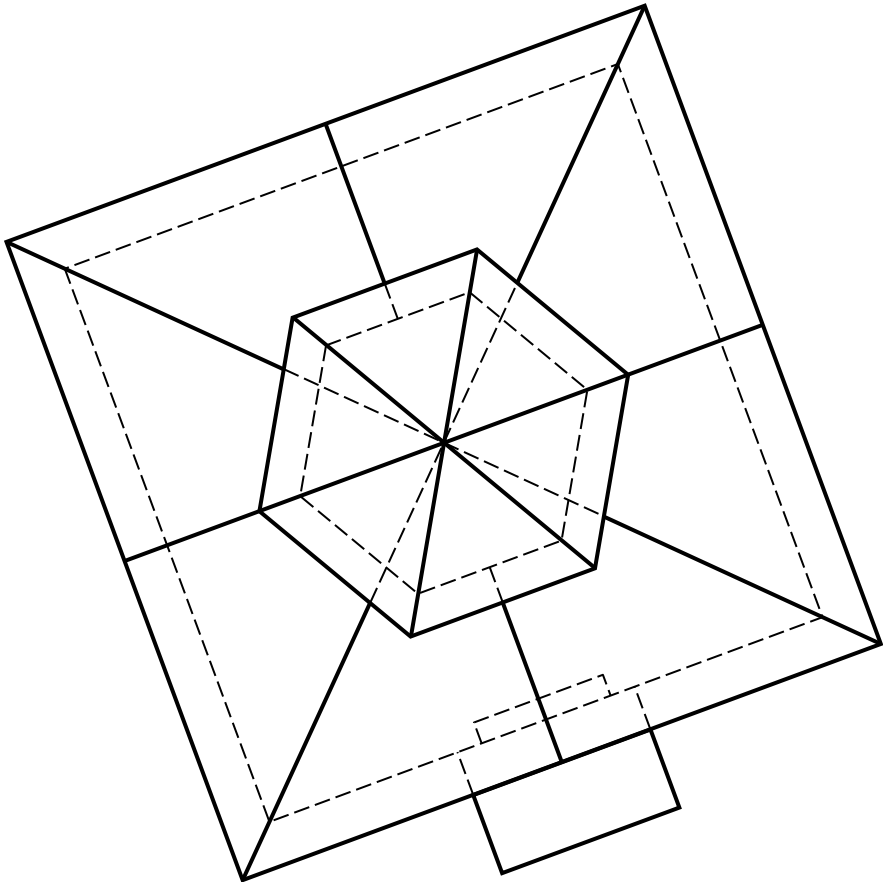
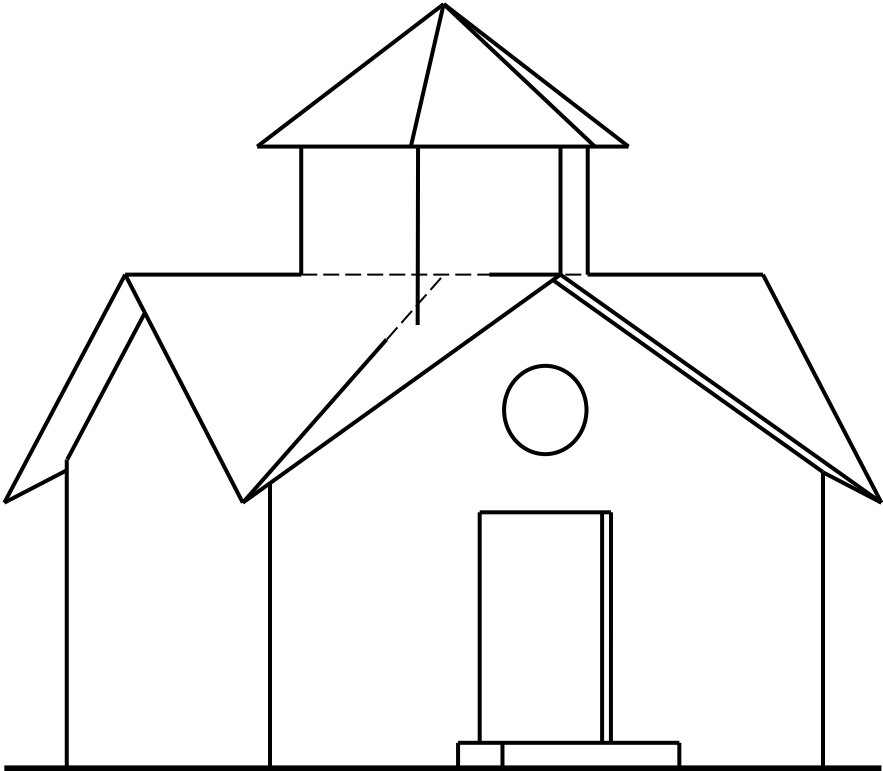

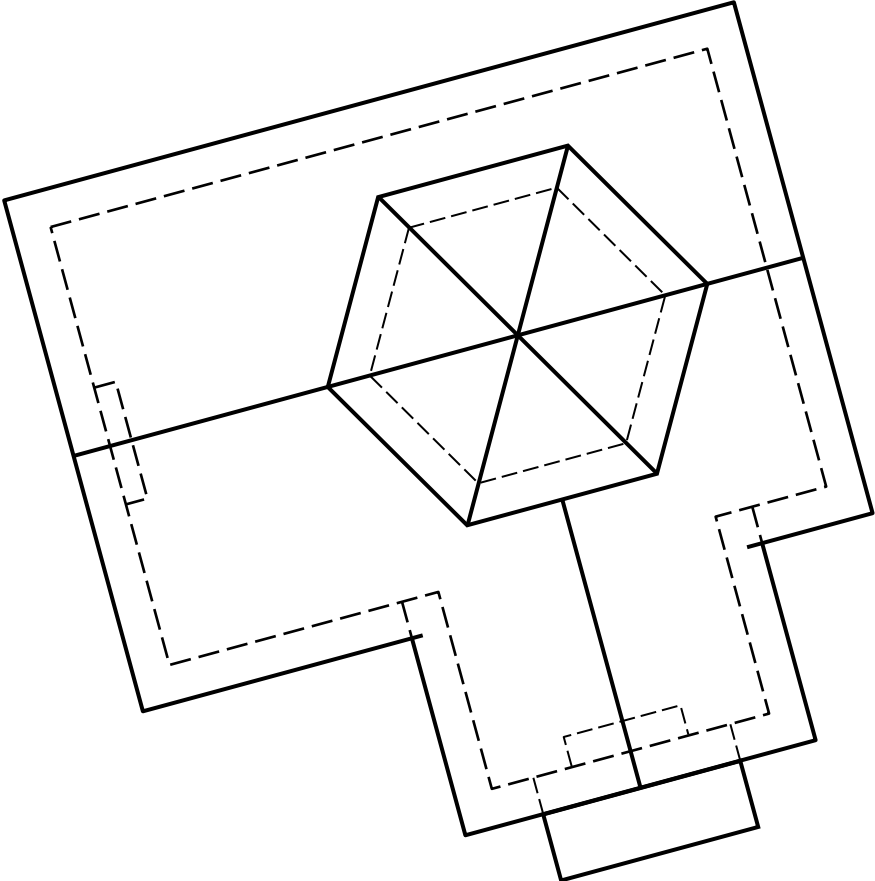
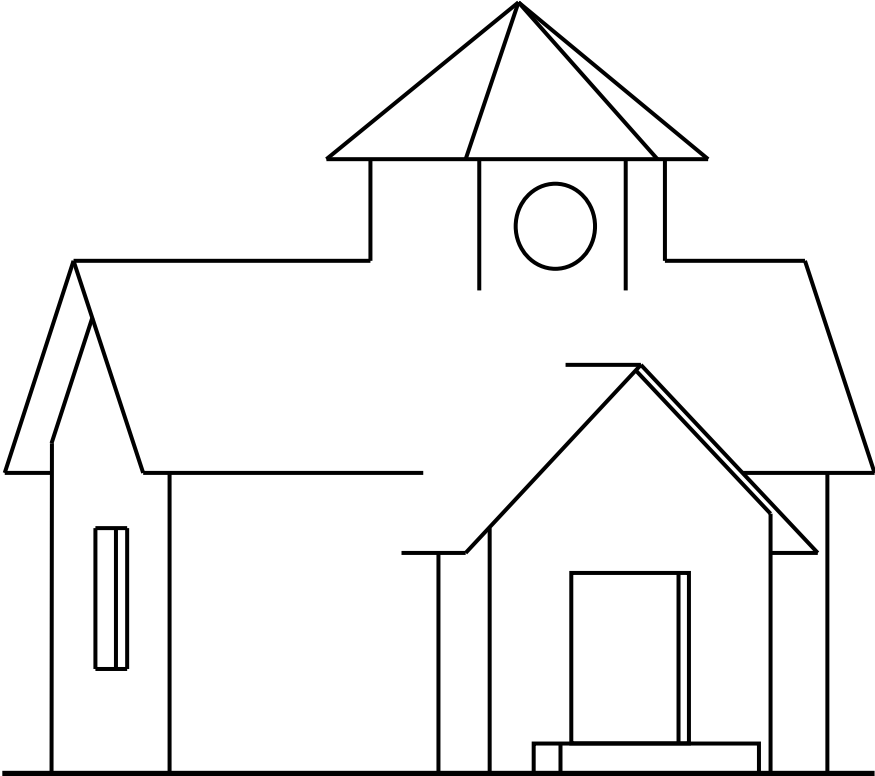

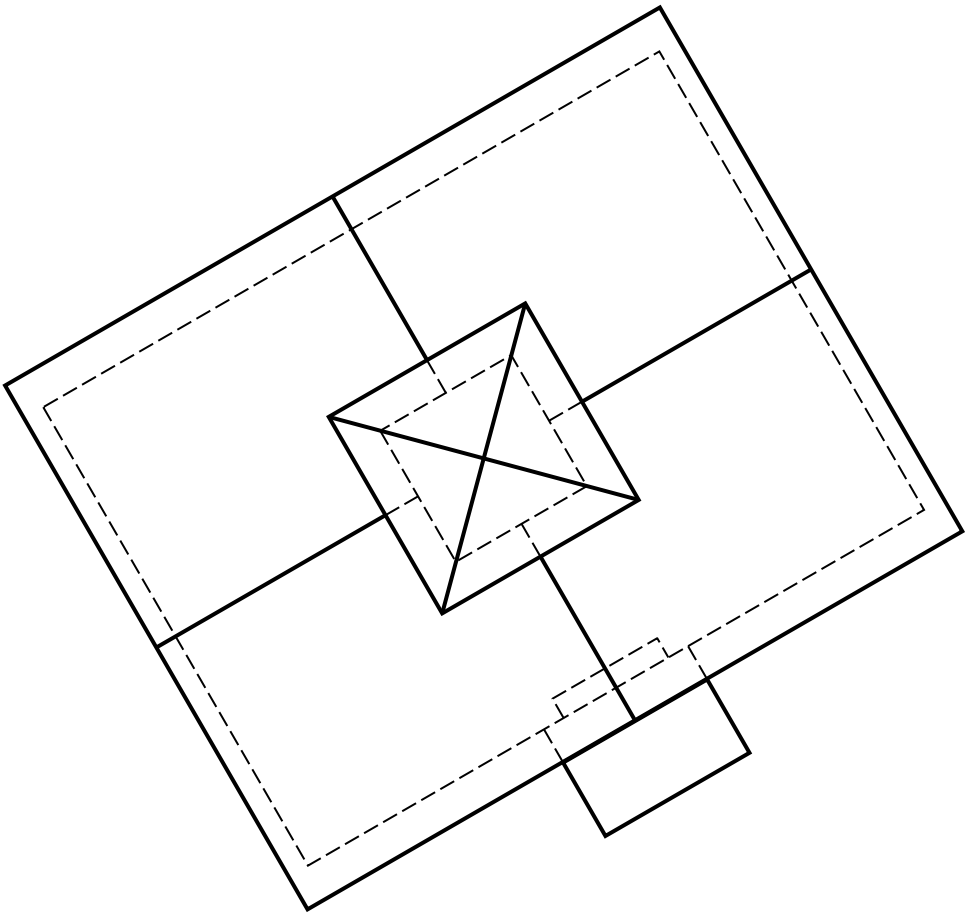
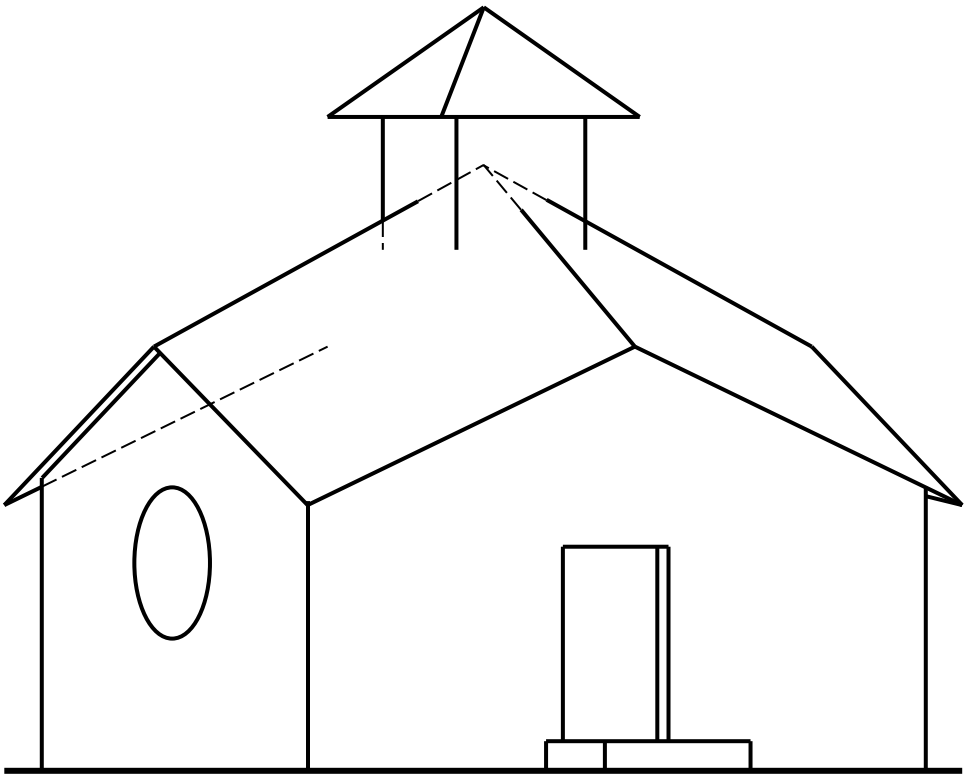

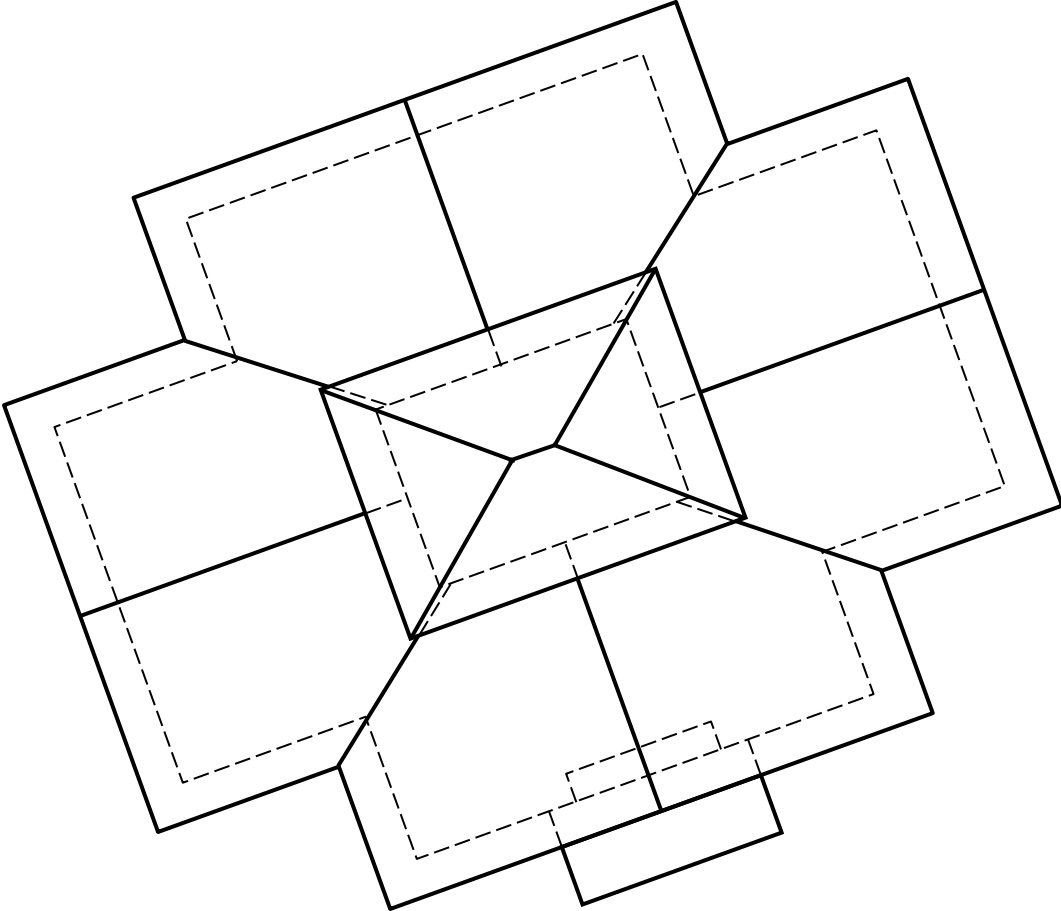
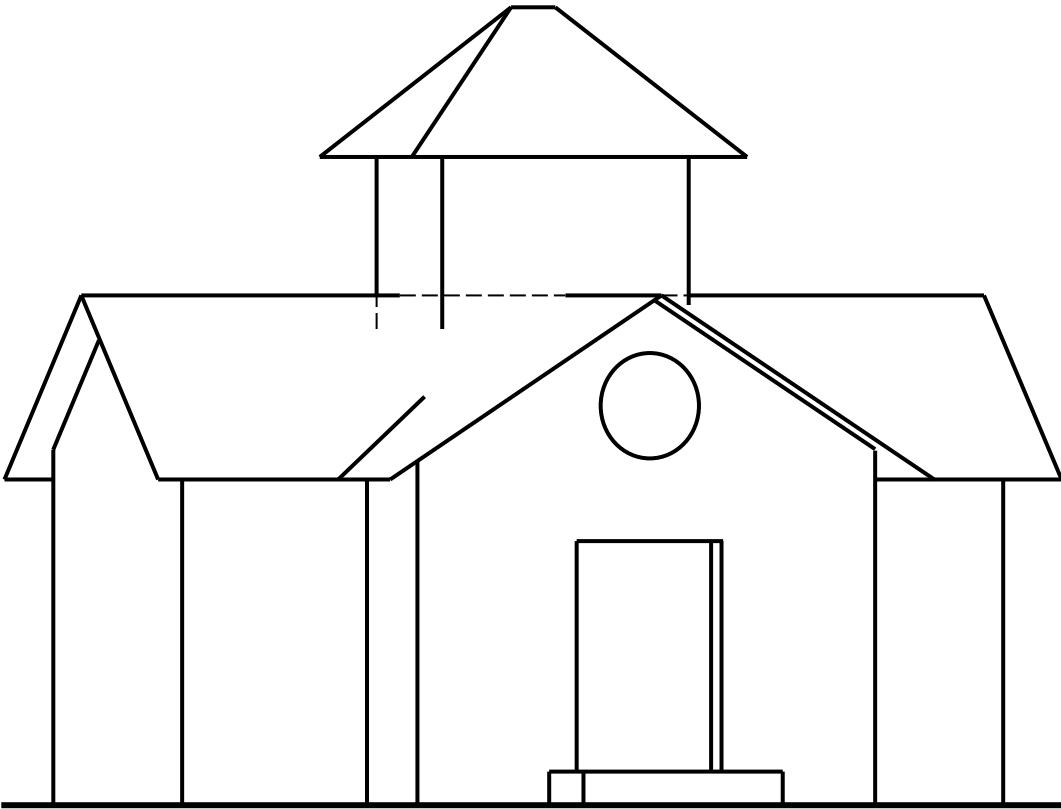

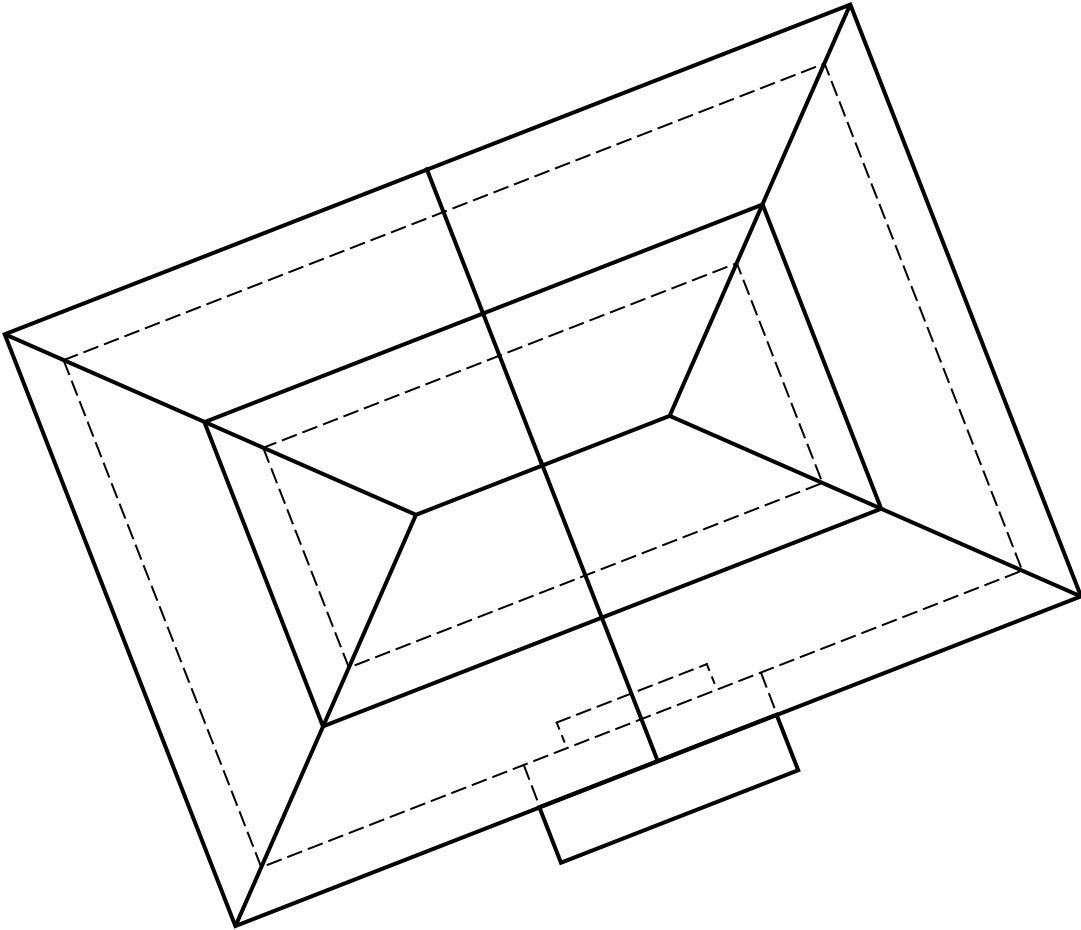
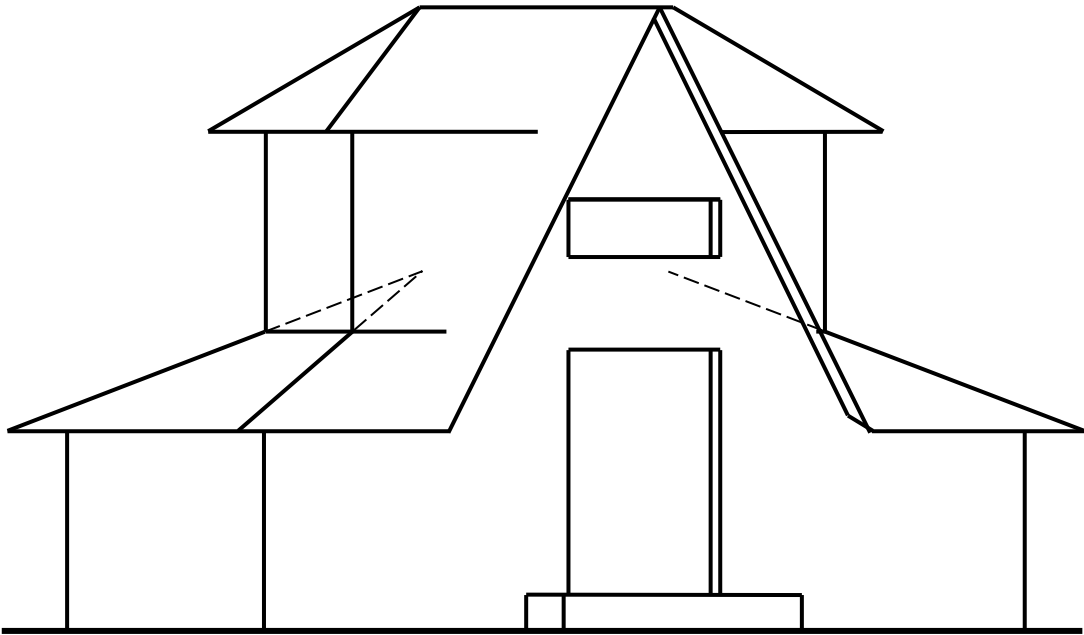

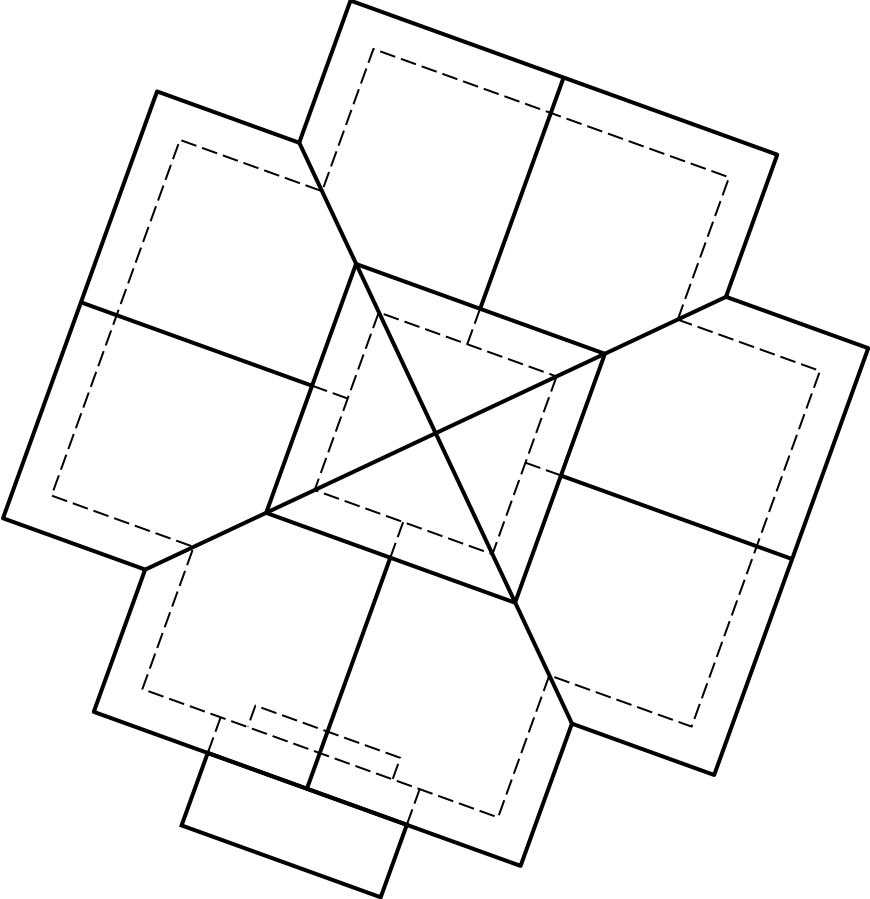
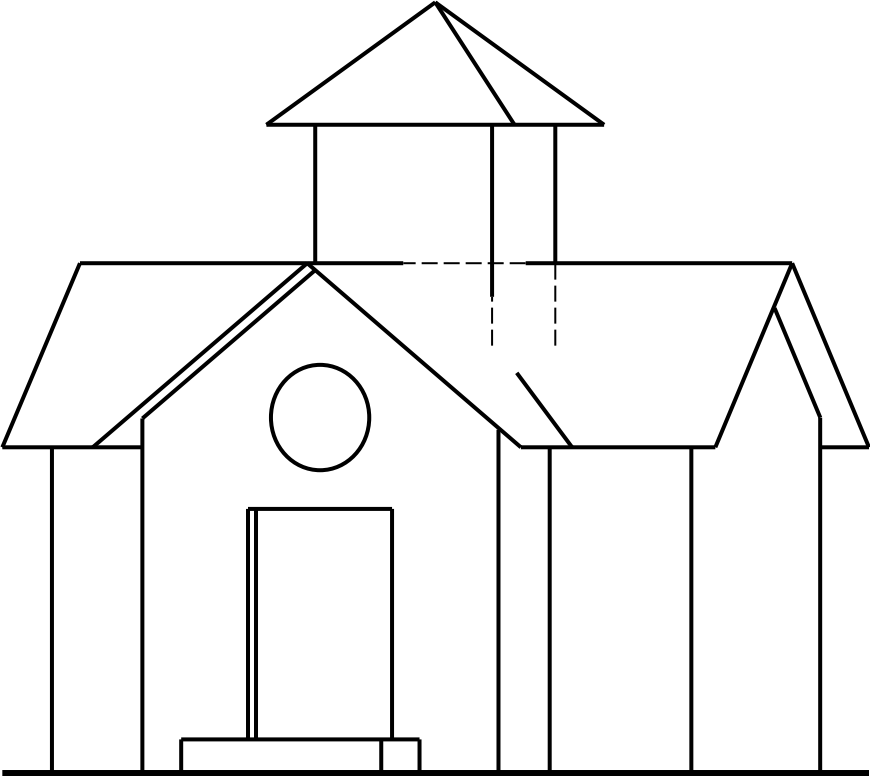

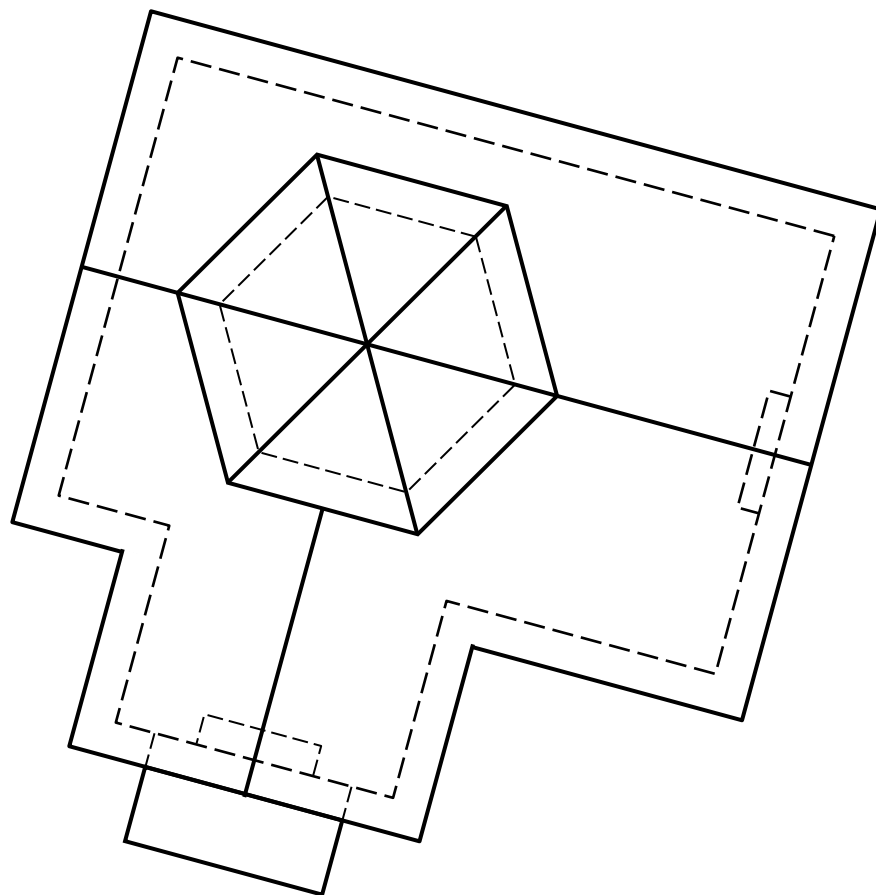
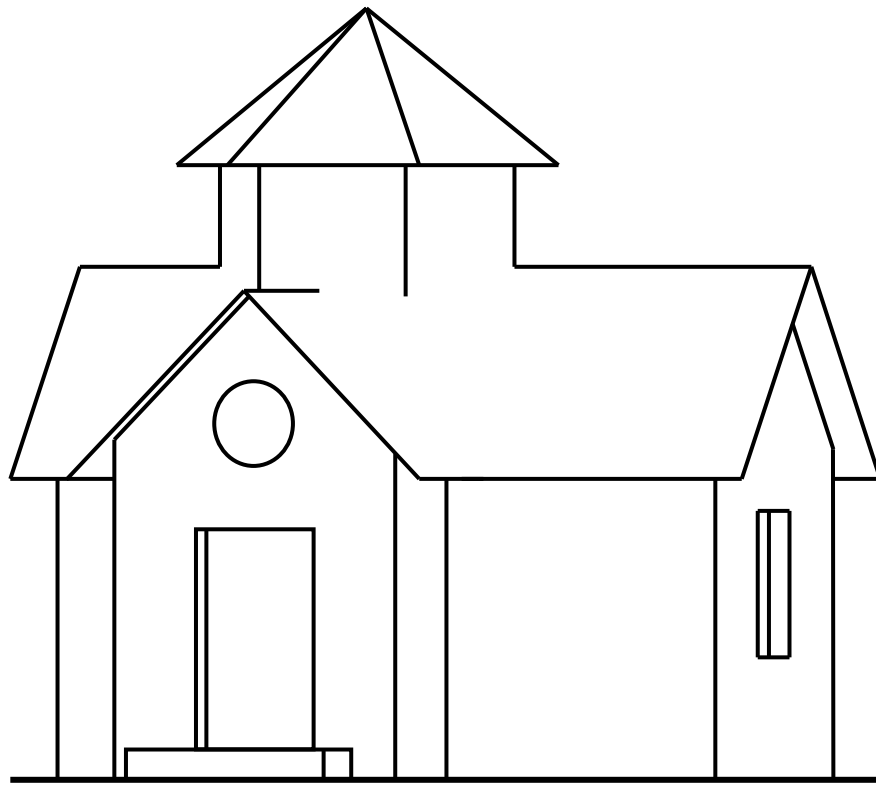

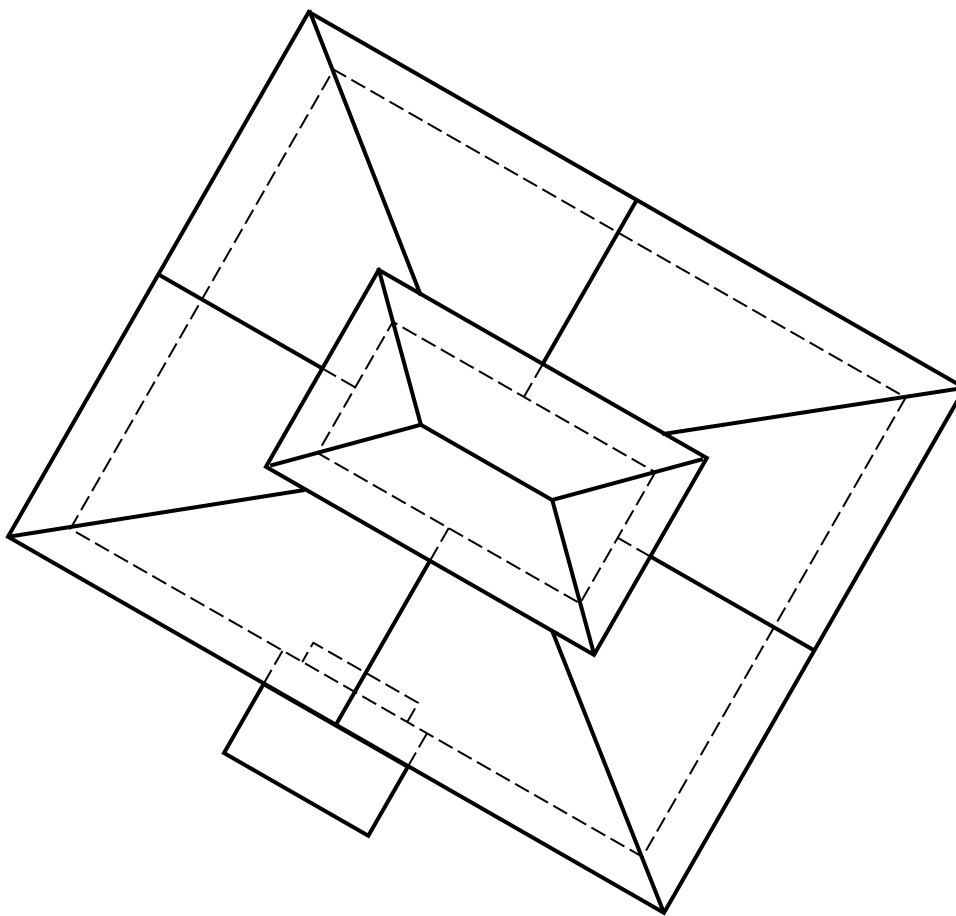
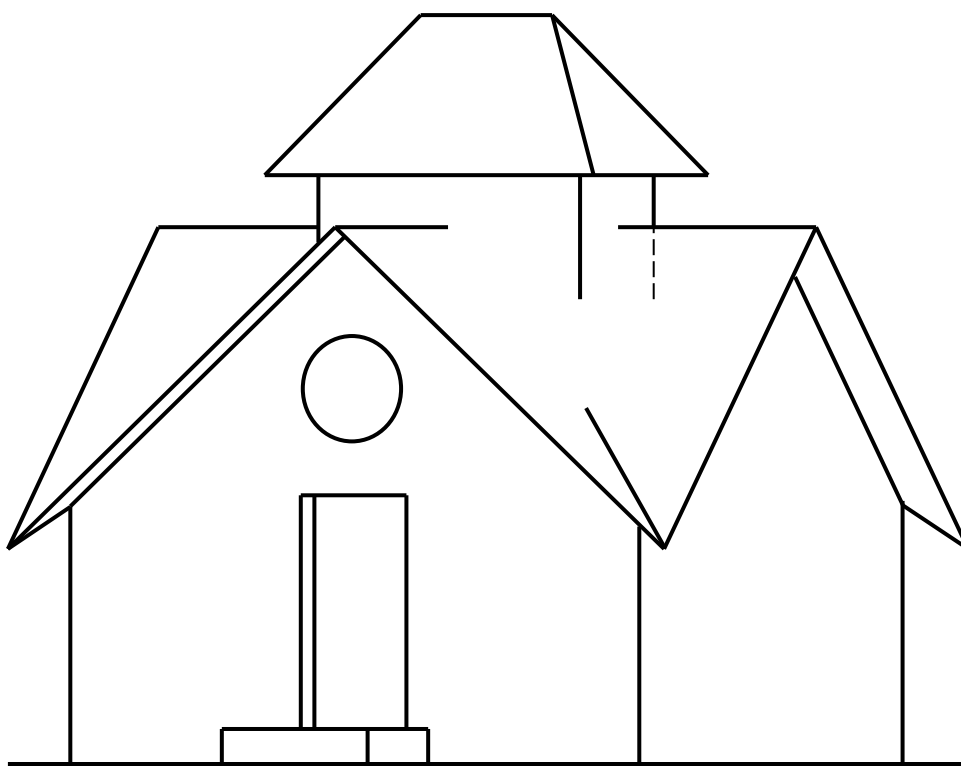

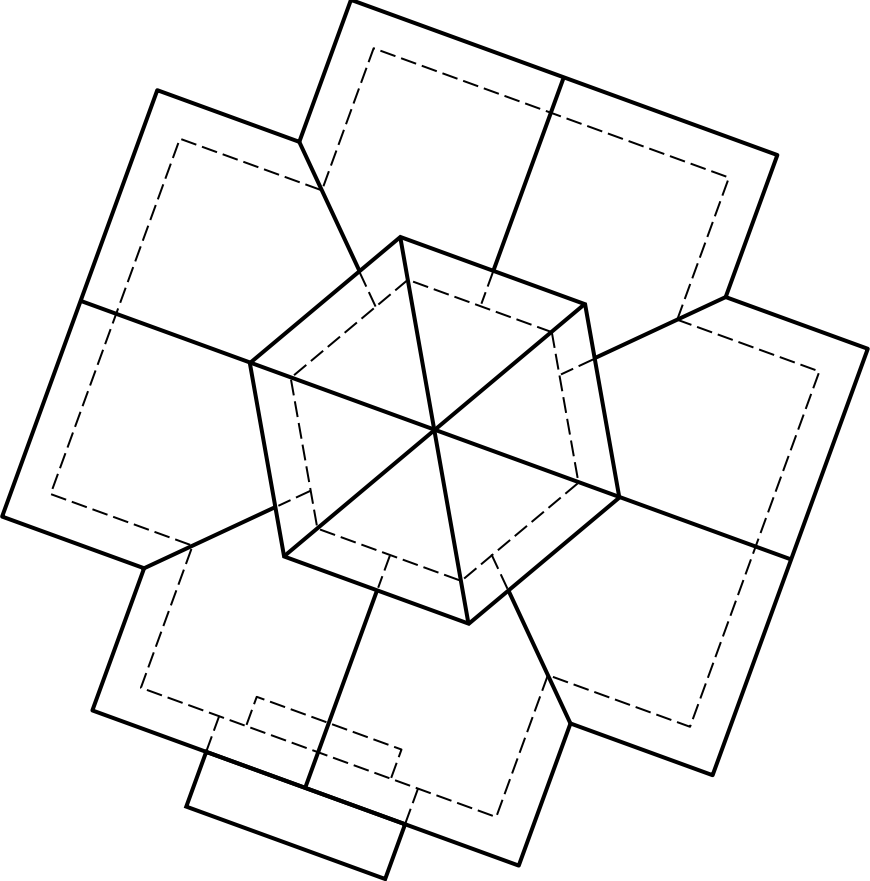
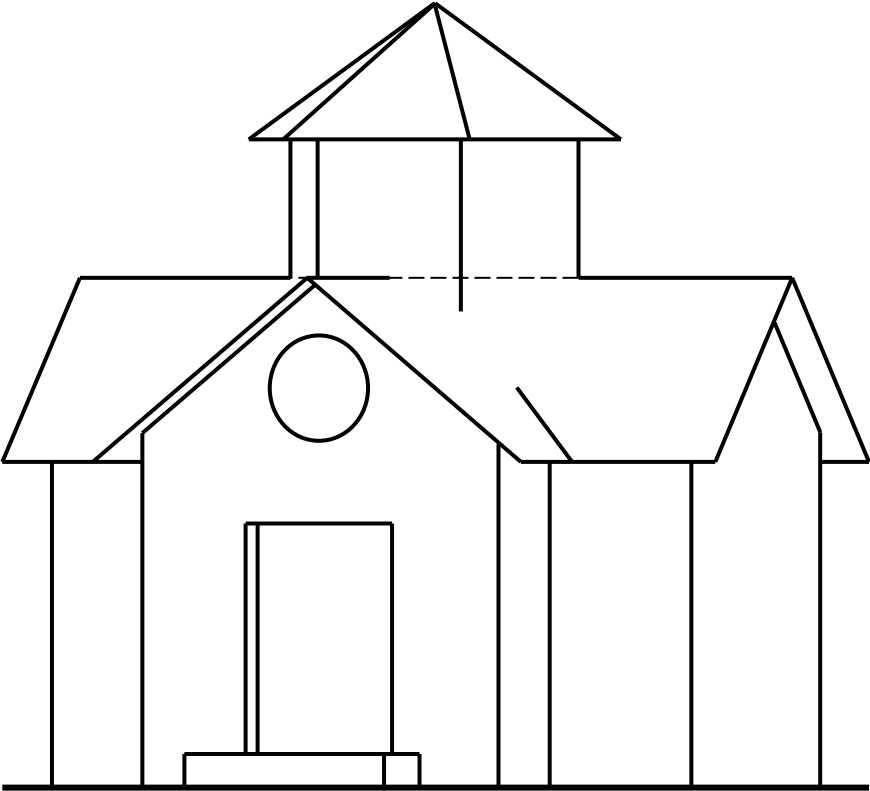

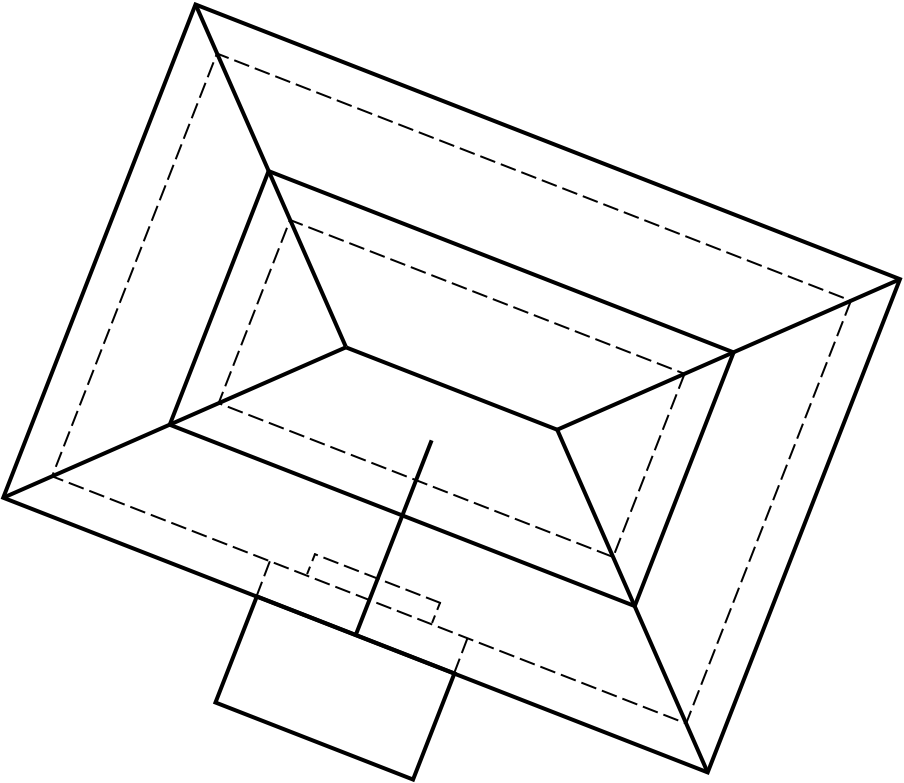
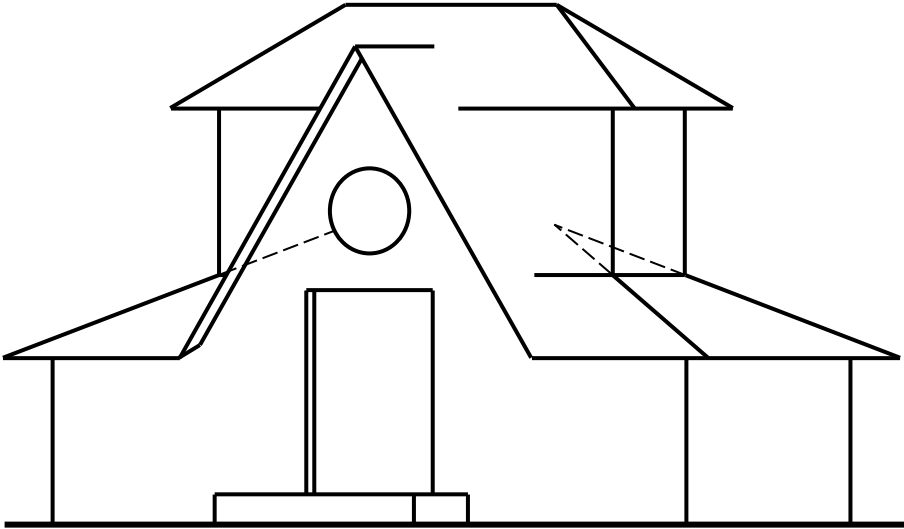

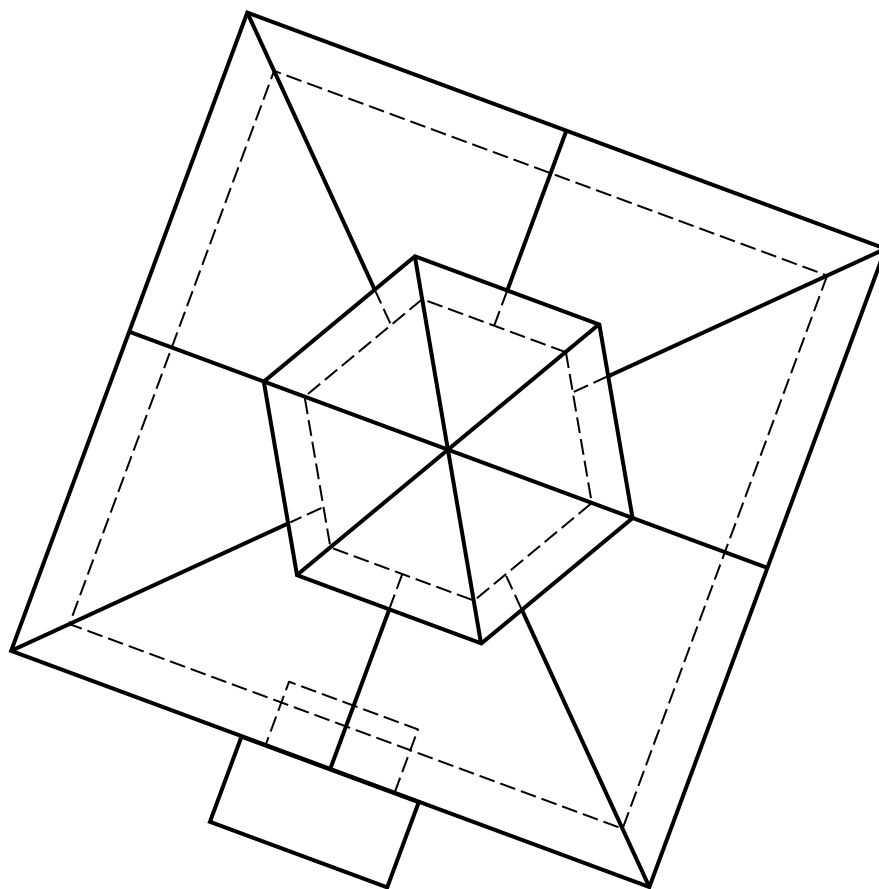
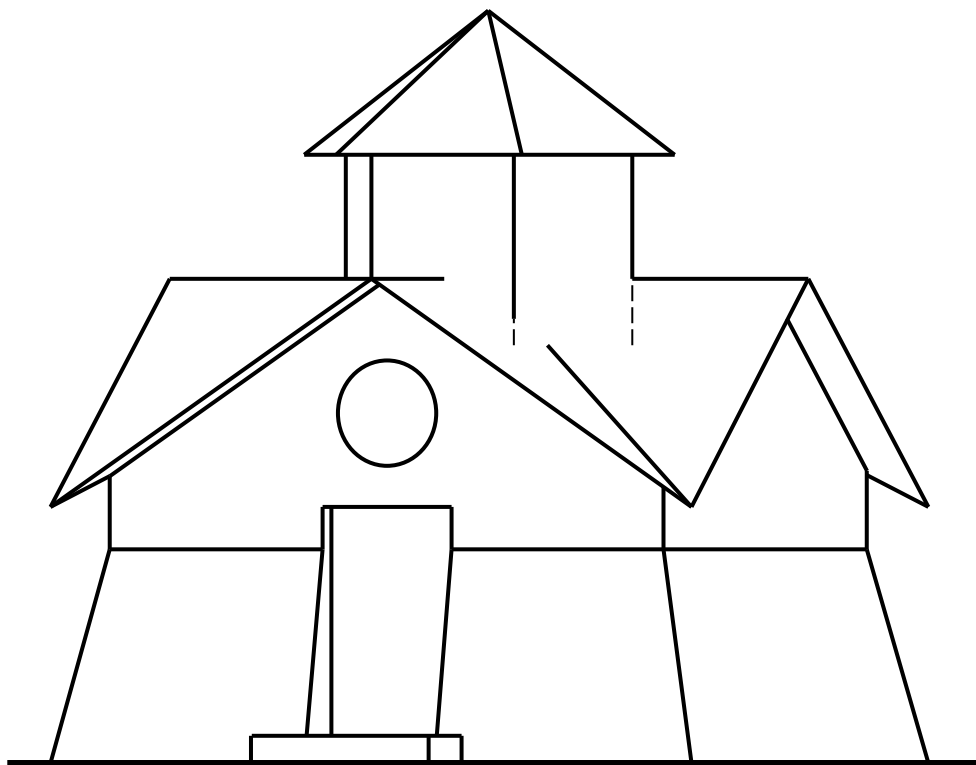

Task 21

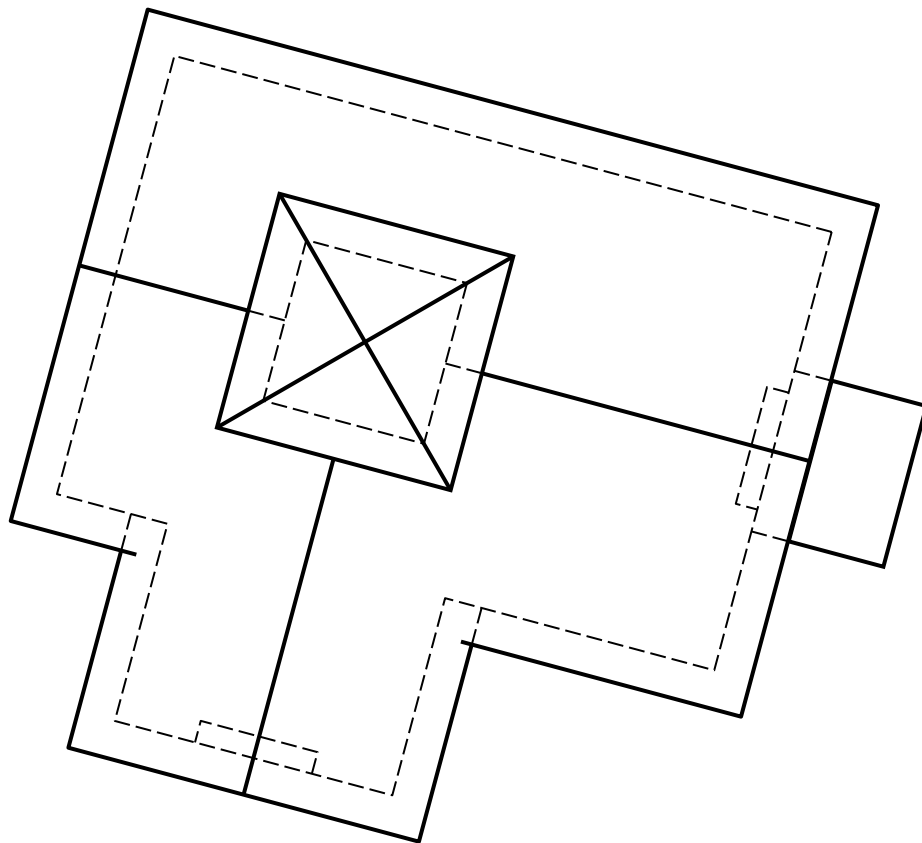
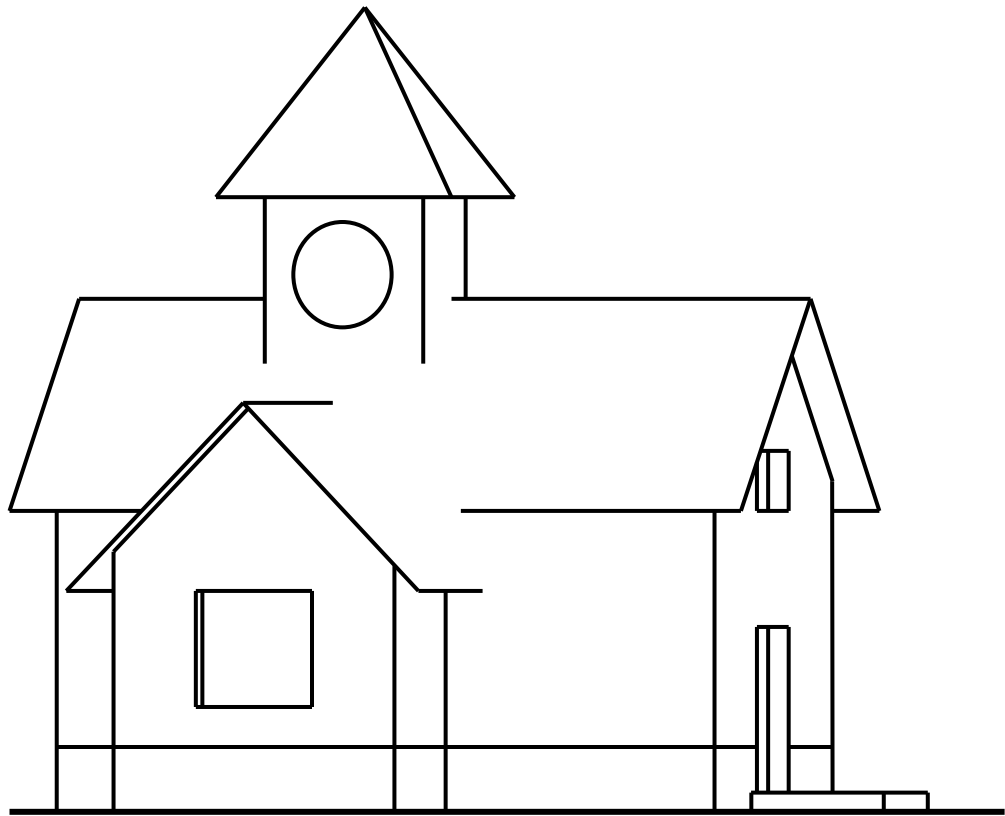

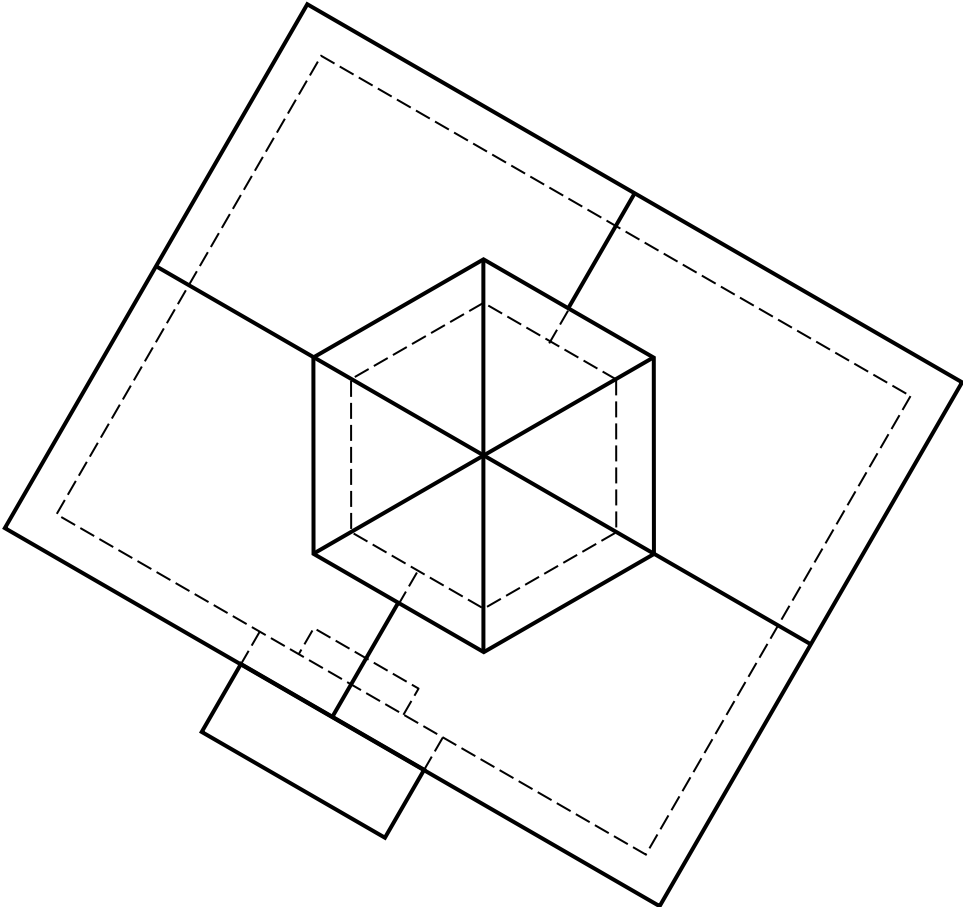
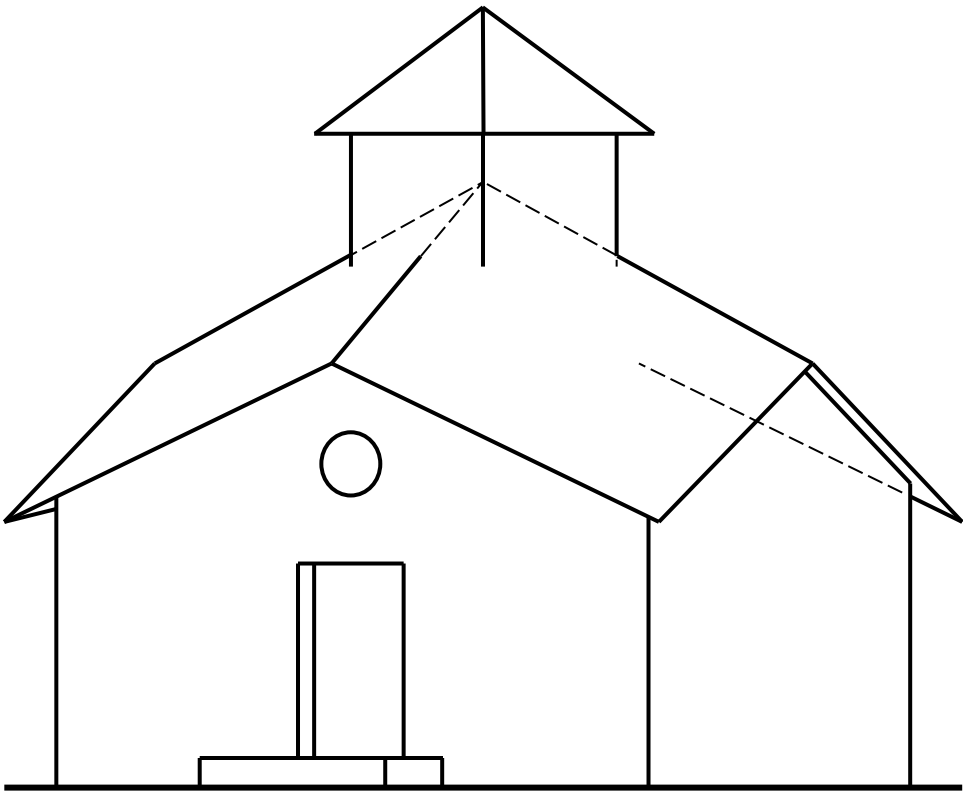

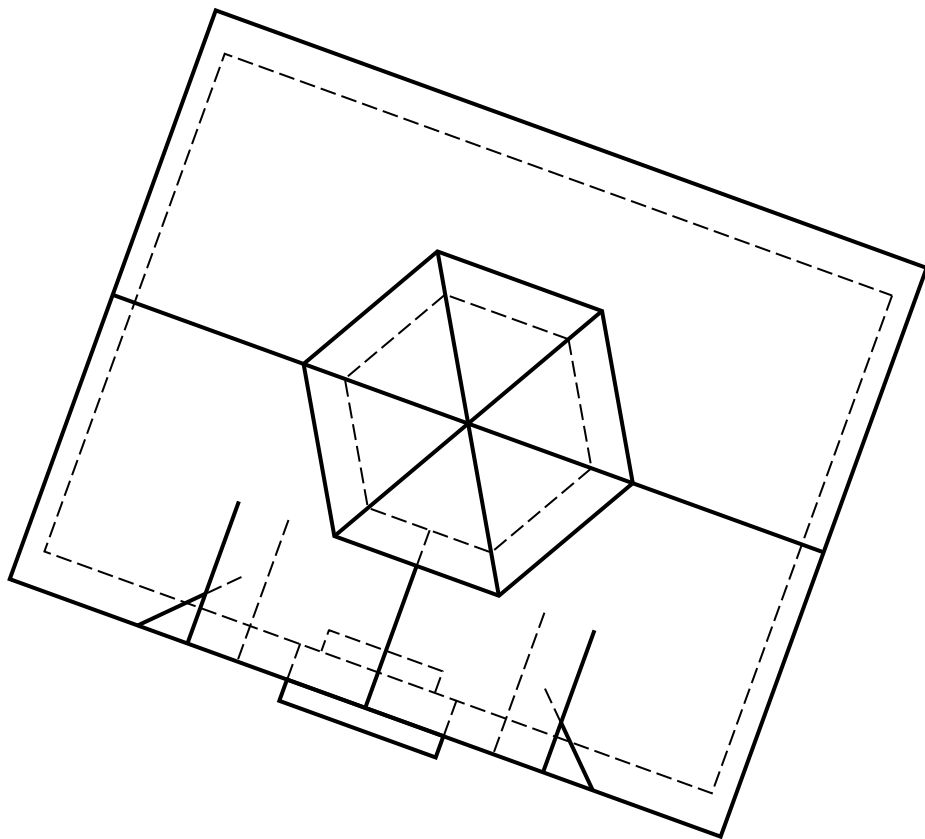
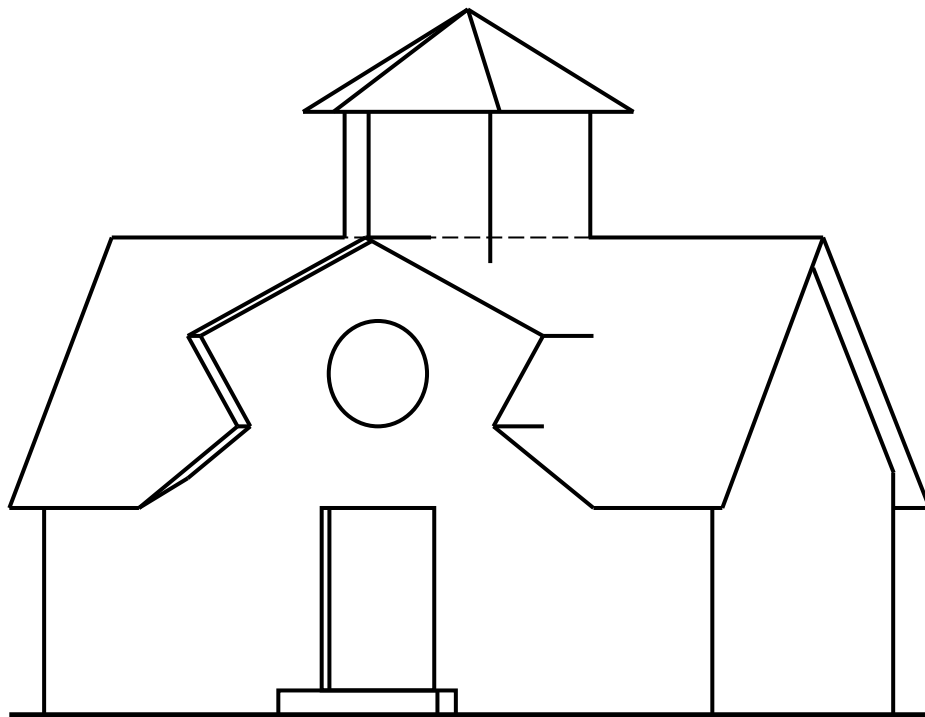

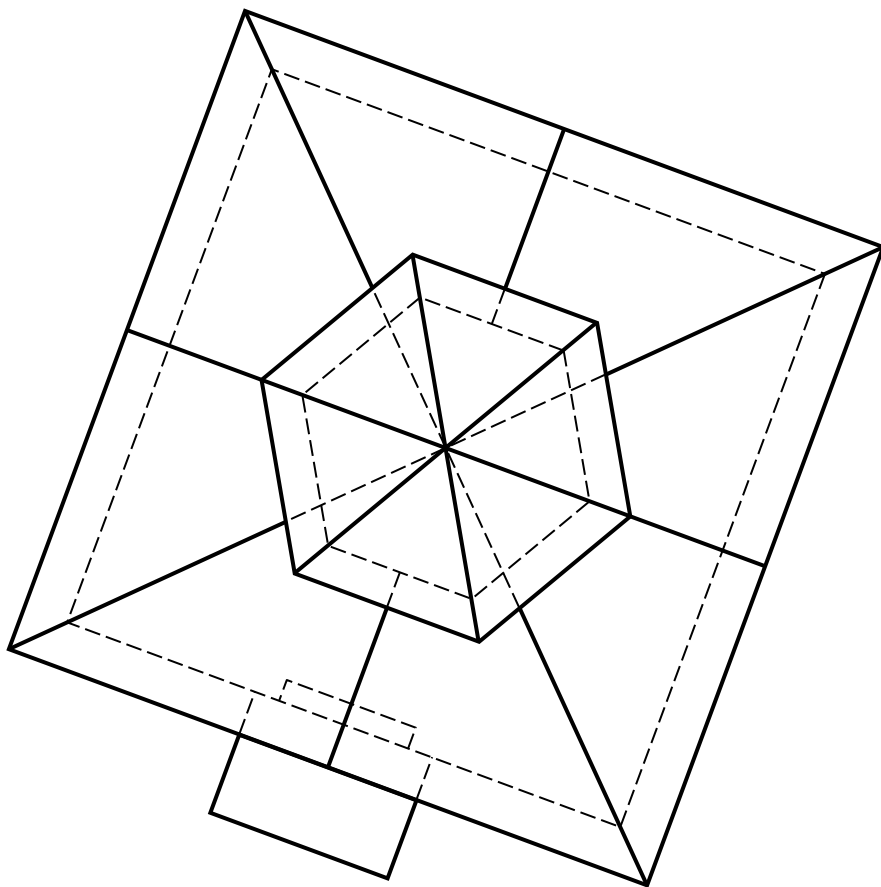
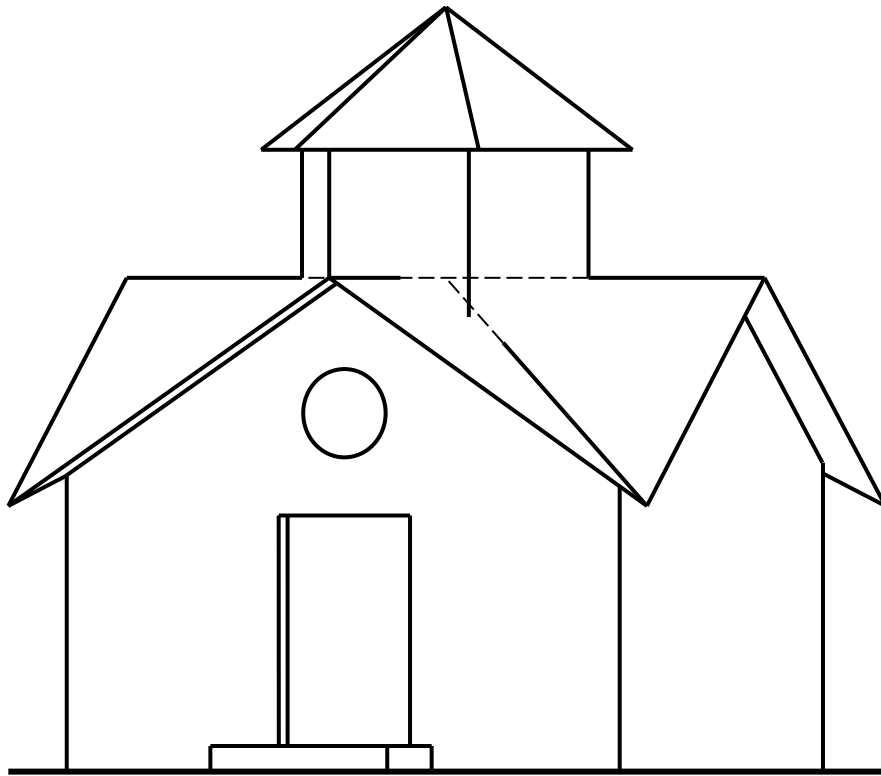

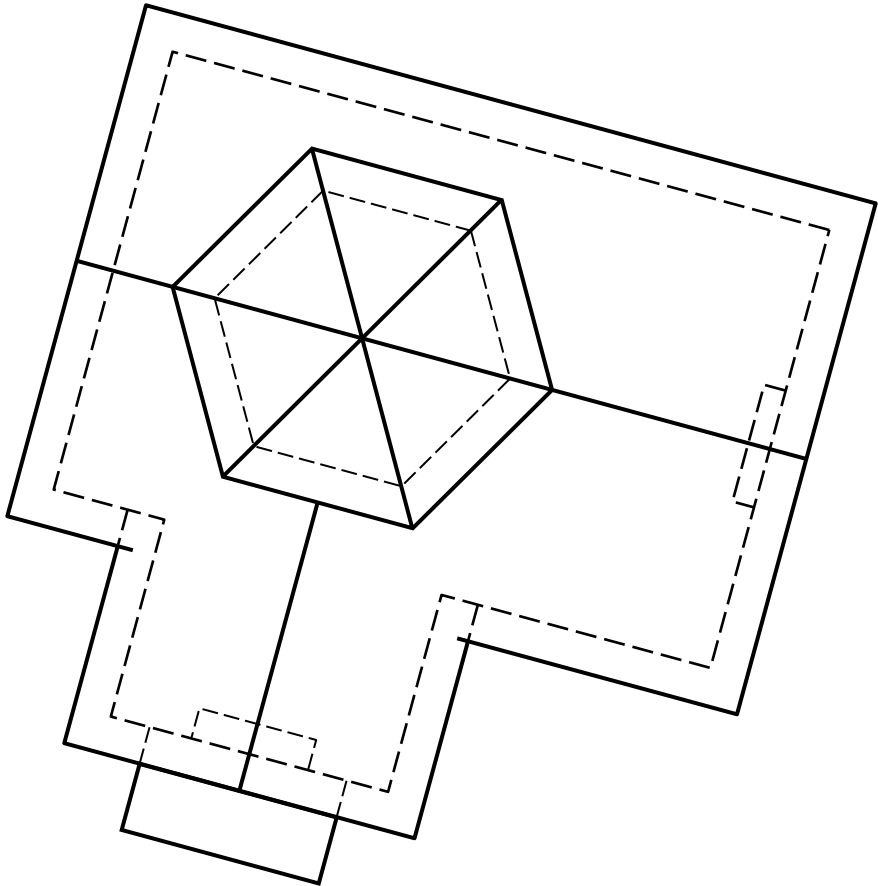
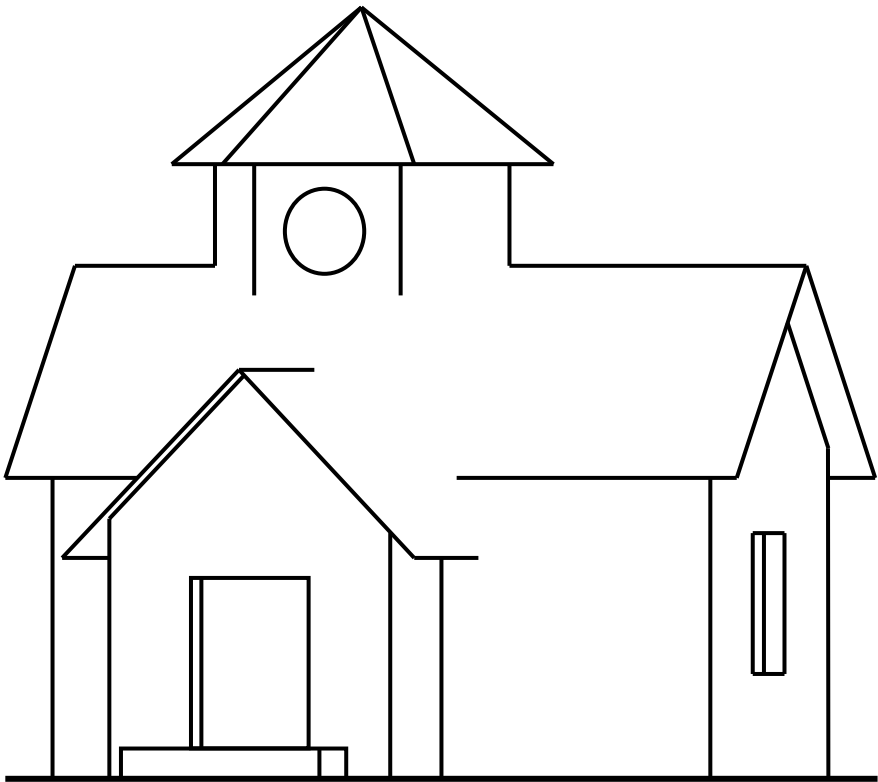

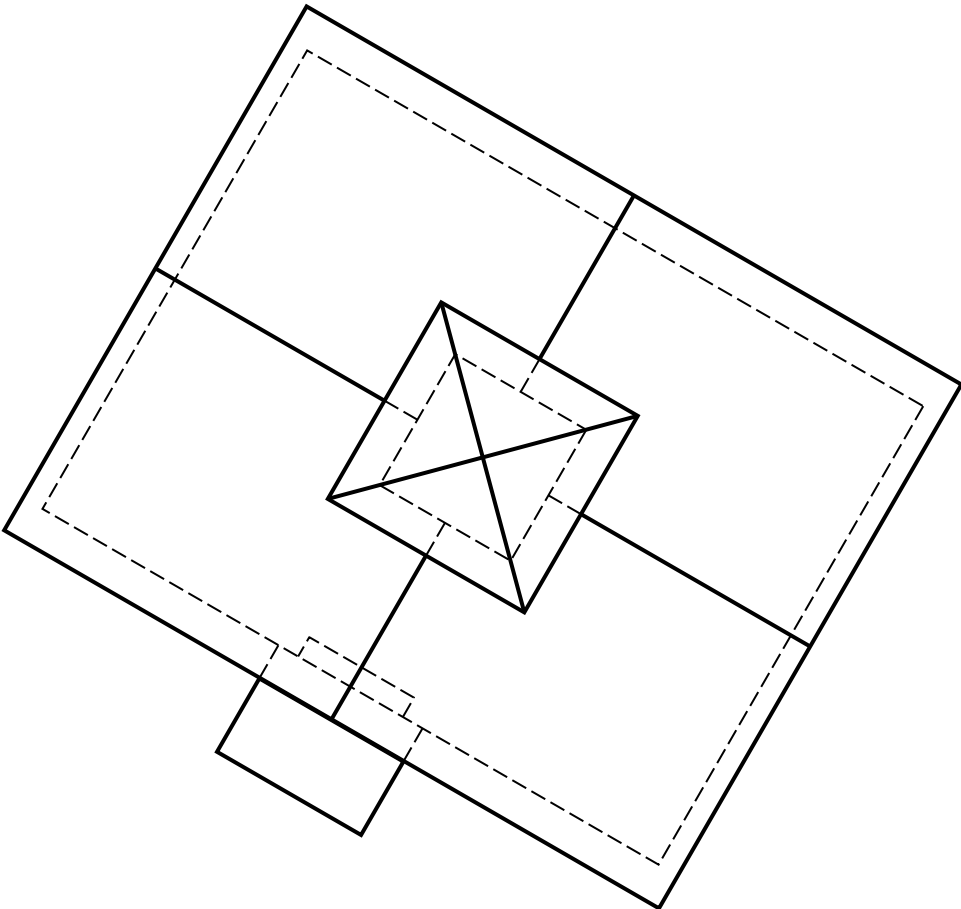
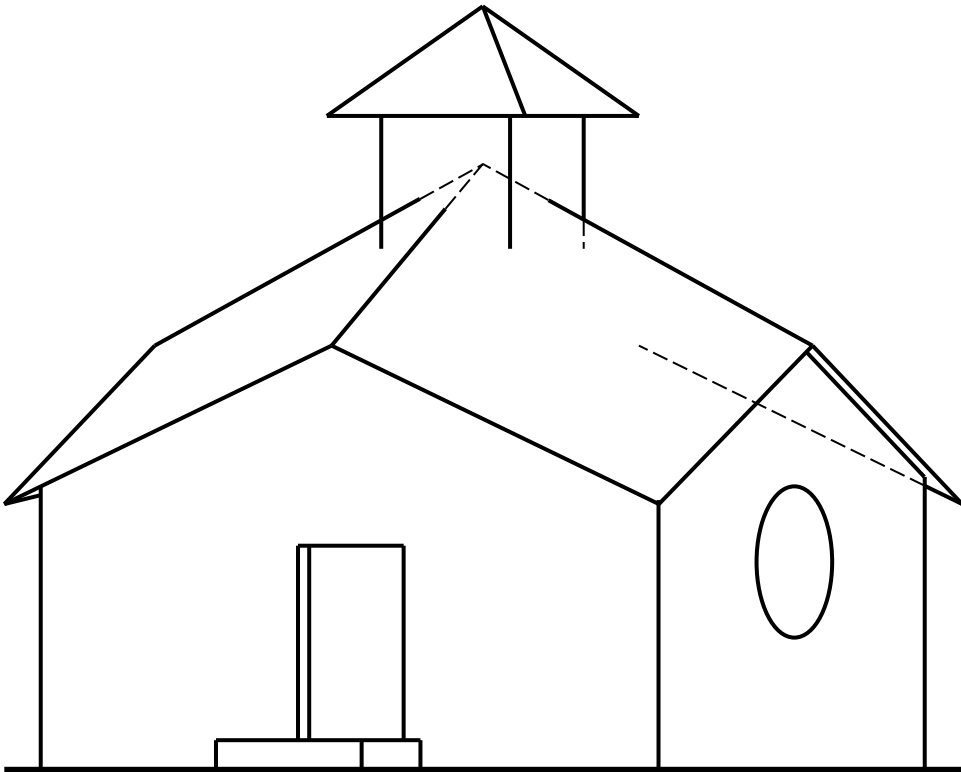

3. LITERATURE

1. Dol's'kyu YE. YE., Yevstyfeyev M. F. Zbirnyk zadach z narysnoyi heometriyi. Kyiv : Derzhbudvydav URSS, 1961. 196 s. [in Ukrainian].

Дольський Є. Є., Євстифеев М. Ф. Збірник задач з нарисної геометрії. Київ : Держбудвидав УРСР, 1961. 196 с.

2. Klimukhin A. G. Sbornik zadach po nachertatel'noy geometrii. Moskva : Stroyizdat, 1982. 216 s. [in Russian].

Климухин А. Г. Сборник задач по начертательной геометрии. Москва : Стройиздат, 1982. 216 с.

3. Koroyev YU. I. Nachertatel'naya geometriya. Moskva : Stroyizdat, 1987. 319 s. [in Russian].

Короев Ю. И. Начертательная геометрия. Москва : Стройиздат, 1987. 319 с.

4. Koroyev YU. I., Kotov YU. V., Orsa YU. N. Sbornik zadach i zadaniy po nachertatel'noy geometrii. Moskva : Stroyizdat, 1989. 176 s. [in Russian].

Короев Ю. И., Котов Ю. В., Орса Ю. Н. Сборник задач и заданий по начертательной геометрии. Москва : Стройиздат, 1989. 176 с.

5. Narysna heometriya / Mykhaylenko V. YE., Yevstifeyev M. F., Koval'ov S. M., Kashchenko O. V. Kyiv : Vyshcha shkola, 2004. 303 s. [in Ukrainian].

Нарисна геометрія / Михайленко В. Є., Євстифеев М. Ф., Ковальов С. М., Кащенко О. В. Київ : Вища школа, 2004. 303 с.

6. Russkevych N. L. Nachertatel'naya heometriya. Kyiv : Vyshcha shkola, 1978. 312 s. [in Russian].

Рускевич Н. Л. Начертательная геометрия. Київ : Вища школа, 1978. 312 с.

7. Timrot Ye. S. Nachertatel'naya geometriya. Moskva : Gosstroyizdat, 1962. 280 s. [in Russian].

Тимрот Е. С. Начертательная геометрия. Москва : Госстройиздат, 1962. 280 с.

Information resources

1. National Library named after V. I. Vernadskyi. URL: <http://www.nbuv.gov.ua/>

2. Rivne Regional Universal Scientific Library (Rivne, Maidan Korolenko, 6). URL: <http://www.lib.rv.ua/>

3. Scientific library of NUWEE (Rivne, st. Oleksy Novaka, 75). URL: <http://nuwm.edu.ua/naukova-biblioteka>

4. Digital repository of NUWEE. URL: <http://ep3.nuwm.edu.ua/view/types/methods/>